



CALL NO. 303

CONTRACT ID. 185013

FLEMING COUNTY

FED/STATE PROJECT NUMBER FD04 035 0111 0007-008

DESCRIPTION KY-111

WORK TYPE BRIDGE REPAIRS

PRIMARY COMPLETION DATE 7/1/2019

LETTING DATE: December 07,2018

Sealed Bids will be received electronically through the Bid Express bidding service until 10:00 AM EASTERN STANDARD TIME December 07,2018. Bids will be publicly announced at 10:00 AM EASTERN STANDARD TIME.

NO PLANS ASSOCIATED WITH THIS PROJECT.

REQUIRED BID PROPOSAL GUARANTY: Not less than 5% of the total bid.

TABLE OF CONTENTS

PART I	SCOPE OF WORK
	<ul style="list-style-type: none">• PROJECT(S), COMPLETION DATE(S), & LIQUIDATED DAMAGES• CONTRACT NOTES• STATE CONTRACT NOTES• ASPHALT MIXTURE• INCIDENTAL SURFACING• COMPACTION OPTION B• SPECIAL NOTE(S) APPLICABLE TO PROJECT• LIQUIDATED DAMAGES• TREE REMOVAL• BRIDGE DEMOLITION, RENOVATION• ASBESTOS ABATEMENT REPORT• RIGHT OF WAY NOTES• UTILITY IMPACT & RAIL CERTIFICATION NOTES• DEPT OF ARMY - NATIONWIDE PERMIT
PART II	SPECIFICATIONS AND STANDARD DRAWINGS
	<ul style="list-style-type: none">• SPECIFICATIONS REFERENCE• SUPPLEMENTAL SPECIFICATION
PART III	EMPLOYMENT, WAGE AND RECORD REQUIREMENTS
	<ul style="list-style-type: none">• LABOR AND WAGE REQUIREMENTS• EXECUTIVE BRANCH CODE OF ETHICS• KENTUCKY EQUAL EMPLOYMENT OPPORTUNITY ACT OF 1978 LOCALITY / STATE• PROJECT WAGE RATES / STATE
PART IV	INSURANCE
PART V	BID ITEMS

PART I
SCOPE OF WORK

ADMINISTRATIVE DISTRICT - 09

CONTRACT ID - 185013

FD04 035 0111 0007-008

COUNTY - FLEMING

PCN - DE03501111813

FD04 035 0111 0007-008

KY-111 ADDRESS DEFICIENCIES OF KY-111 BRIDGE OVER BRANCH OF HILLSBORO CREEK (035B00018N)
FROM MP 7.568 TO MP 7.576, A DISTANCE OF 0.01 MILES.BRIDGE REPAIRS SYP NO. 09-10005.00.
GEOGRAPHIC COORDINATES LATITUDE 38:19:14.00 LONGITUDE 83:39:44.00

COMPLETION DATE(S):

COMPLETED BY 07/01/2019

APPLIES TO ENTIRE CONTRACT

CONTRACT NOTES

PROPOSAL ADDENDA

All addenda to this proposal must be applied when calculating bid and certified in the bid packet submitted to the Kentucky Department of Highways. Failure to use the correct and most recent addenda may result in the bid being rejected.

BID SUBMITTAL

Bidder must use the Department's electronic bidding software. The Bidder must download the bid file located on the Bid Express website (www.bidx.com) to prepare a bid packet for submission to the Department. The bidder must submit electronically using Bid Express.

JOINT VENTURE BIDDING

Joint venture bidding is permissible. All companies in the joint venture must be prequalified in one of the work types in the Qualifications for Bidders for the project. The bidders must get a vendor ID for the joint venture from the Division of Construction Procurement and register the joint venture as a bidder on the project. Also, the joint venture must obtain a digital ID from Bid Express to submit a bid. A joint bid bond of 5% may be submitted for both companies or each company may submit a separate bond of 5%.

UNDERGROUND FACILITY DAMAGE PROTECTION

The contractor shall make every effort to protect underground facilities from damage as prescribed in the Underground Facility Damage Protection Act of 1994, Kentucky Revised Statute KRS 367.4901 to 367.4917. It is the contractor's responsibility to determine and take steps necessary to be in compliance with federal and state damage prevention directives. When prescribed in said directives, the contractor shall submit Excavation Locate Requests to the Kentucky Contact Center (KY811) via web ticket entry. The submission of this request does not relieve the contractor from the responsibility of contacting non-member facility owners, whom shall be contacted through their individual Protection Notification Center. Non-compliance with these directives can result in the enforcement of penalties.

REGISTRATION WITH THE SECRETARY OF STATE BY A FOREIGN ENTITY

Pursuant to KRS 176.085(1)(b), an agency, department, office, or political subdivision of the Commonwealth of Kentucky shall not award a state contract to a person that is a foreign entity required by [KRS 14A.9-010](#) to obtain a certificate of authority to transact business in the Commonwealth ("certificate") from the Secretary of State under [KRS 14A.9-030](#) unless the person produces the certificate within fourteen (14) days of the bid or proposal opening. If the foreign entity is not required to obtain a certificate as provided in [KRS 14A.9-010](#), the foreign entity should identify the applicable exception. Foreign entity is defined within [KRS 14A.1-070](#).

For all foreign entities required to obtain a certificate of authority to transact business in the Commonwealth, if a copy of the certificate is not received by the contracting agency within the time frame identified above, the foreign entity's solicitation response shall be deemed non-responsive or the awarded contract shall be cancelled.

Businesses can register with the Secretary of State at <https://secure.kentucky.gov/sos/ftbr/welcome.aspx>.

SPECIAL NOTE FOR PROJECT QUESTIONS DURING ADVERTISEMENT

Questions about projects during the advertisement should be submitted in writing to the Division of Construction Procurement. This may be done by fax (502) 564-7299 or email to kytc.projectquestions@ky.gov. The Department will attempt to answer all submitted questions. The Department reserves the right not to answer if the question is not pertinent or does not aid in clarifying the project intent.

The deadline for posting answers will be 3:00 pm Eastern Daylight Time, the day preceding the Letting. Questions may be submitted until this deadline with the understanding that the later a question is submitted, the less likely an answer will be able to be provided.

The questions and answers will be posted for each Letting under the heading "Questions & Answers" on the Construction Procurement website (www.transportation.ky.gov/contract). The answers provided shall be considered part of this Special Note and, in case of a discrepancy, will govern over all other bidding documents.

HARDWOOD REMOVAL RESTRICTIONS

The US Department of Agriculture has imposed a quarantine in Kentucky and several surrounding states, to prevent the spread of an invasive insect, the emerald ash borer. Hardwood cut in conjunction with the project may not be removed from the state. Chipping or burning on site is the preferred method of disposal.

INSTRUCTIONS FOR EXCESS MATERIAL SITES AND BORROW SITES

Identification of excess material sites and borrow sites shall be the responsibility of the Contractor. The Contractor shall be responsible for compliance with all applicable state and federal laws and may wish to consult with the US Fish and Wildlife Service to seek protection under Section 10 of the Endangered Species Act for these activities.

ACCESS TO RECORDS

The contractor, as defined in KRS 45A.030 (9) agrees that the contracting agency, the Finance and Administration Cabinet, the Auditor of Public Accounts, and the Legislative Research Commission, or their duly authorized representatives, shall have access to any books, documents, papers, records, or other evidence, which are directly pertinent to this contract for the purpose of financial audit or program review. Records and other prequalification information confidentially

disclosed as part of the bid process shall not be deemed as directly pertinent to the contract and shall be exempt from disclosure as provided in KRS 61.878(1)(c). The contractor also recognizes that any books, documents, papers, records, or other evidence, received during a financial audit or program review shall be subject to the Kentucky Open Records Act, KRS 61.870 to 61.884.

In the event of a dispute between the contractor and the contracting agency, Attorney General, or the Auditor of Public Accounts over documents that are eligible for production and review, the Finance and Administration Cabinet shall review the dispute and issue a determination, in accordance with Secretary's Order 11-004.

April 30, 2018

SPECIAL NOTE FOR RECIPROCAL PREFERENCE

RECIPROCAL PREFERENCE TO BE GIVEN BY PUBLIC AGENCIES TO RESIDENT BIDDERS

By reference, KRS 45A.490 to 45A.494 are incorporated herein and in compliance regarding the bidders residency. Bidders who want to claim resident bidder status should complete the Affidavit for Claiming Resident Bidder Status along with their bid in the electronic bidding software. Submittal of the Affidavit should be done along the bid in Bid Express.

April 30, 2018

ASPHALT MIXTURE

Unless otherwise noted, the Department estimates the rate of application for all asphalt mixtures to be 110 lbs/sy per inch of depth.

INCIDENTAL SURFACING

The Department has included in the quantities of asphalt mixtures established in the proposal estimated quantities required for resurfacing or surfacing mailbox turnouts, farm field entrances, residential and commercial entrances, curve widening, ramp gores and tapers, and road and street approaches, as applicable. Pave these areas to the limits as shown on Standard Drawing RPM-110-06 or as directed by the Engineer. In the event signal detectors are present in the intersecting streets or roads, pave the crossroads to the right of way limit or back of the signal detector, whichever is the farthest back of the mainline. Surface or resurface these areas as directed by the Engineer. The Department will not measure placing and compacting for separate payment but shall be incidental to the Contract unit price for the asphalt mixtures.

OPTION B

Be advised that the Department will control and accept compaction of asphalt mixtures furnished on this project under OPTION B in accordance with Sections 402 and 403.

INDEX OF SHEETS

Sheet No.	Description
S1	TITLE & LOCATION MAP
S2-S3	GENERAL NOTES
S4	PLAN & ELEVATION
S5	TYPICAL SECTION
S6	ABUTMENT DETAILS
S7	STEEL DETAILS
S8	DECK DETAILS
S9	SUPERSTRUCTURE DETAILS
S10	DRIP STRIP DETAILS

SPECIAL NOTES

Concrete Patching
Concrete Sealing
Epoxy Infection Crack Repair

SPECIAL PROVISIONS

STANDARD DRAWINGS

BR-100-12 Elastomeric Bearing Pads for Prestressed Beams
BR-100-14 Bearing Details
BR-100-15 Rolling System, Type II
BR-100-16 Reinforce Expansion Joints and Armored Edges
BR-100-17 Guardrail System Transition
S-100-003 Rolling System, Type II Guardrail Treatment

SPECIFICATIONS

2012 Standard Specifications for Road and Bridge Construction,
2017 ASHTO LRFD Bridge Construction Specifications with Current Interims.

DATE: 10/25/2018
DESIGNED BY: S. Jeffrey
CHECKED BY: J. Pieterse
DETAILED BY: K. McHenry
J. Pieterse

Commonwealth of Kentucky
DEPARTMENT OF HIGHWAYS

FLEMMING
ROUTE KY 111
BRANCH OF HILLSBORO CREEK
TITLE & LOCATION MAP

PREPARED BY:
AECOM

SHEET NO.
BRIDGING KENTUCKY
PROJECT NO.
27835

KENTUCKY TRANSPORTATION CABINET DEPARTMENT OF HIGHWAYS BRIDGE REHABILITATION PLANS

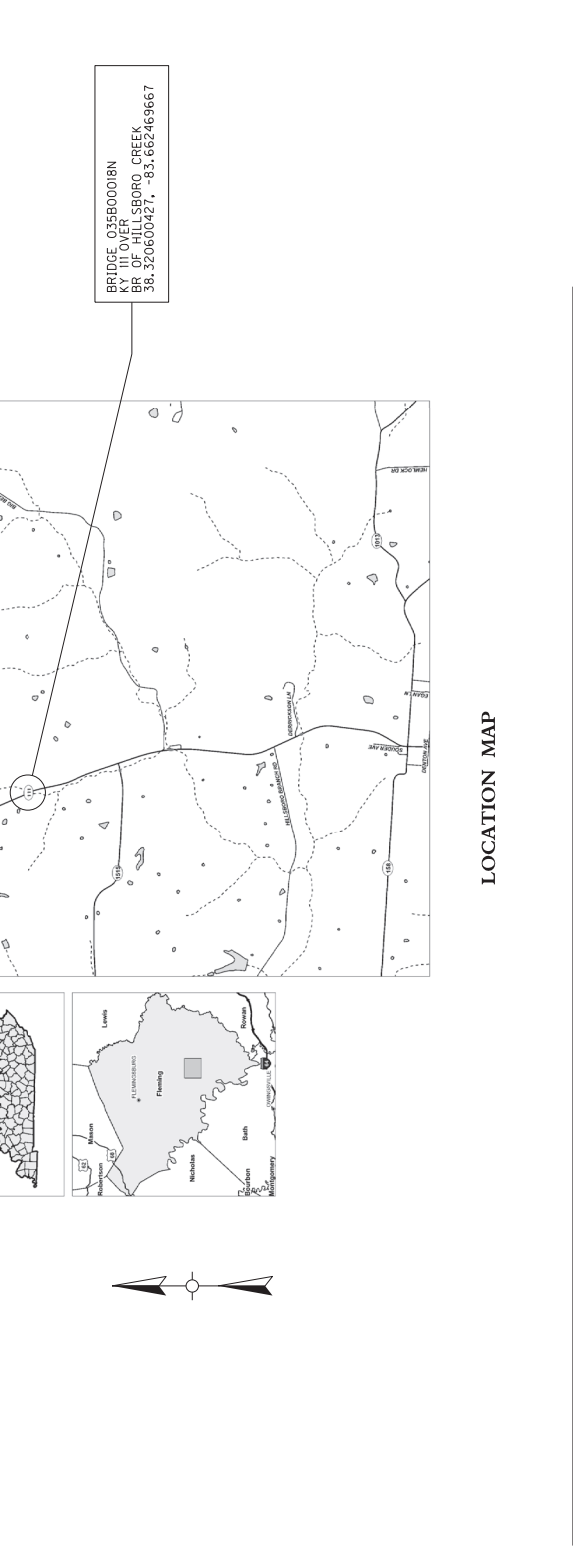

ESTIMATE OF QUANTITIES

BID ITEM CODE	UNIT	QUANTITY	UNIT PRICE	TOTAL PRICE	DESCRIPTION
0804	Concrete Class "AA"	38			Concrete Class "AA"
0269	Demolition	1			Demolition
0260	Maintain and Control Traffic	1			Maintain and Control Traffic
0801	Remove Superstructure	1			Remove Superstructure
0801	Remove Superstructure	1			Remove Superstructure
0801	Shear Connectors	1			Shear Connectors
0870	Remove Guardrail	150			Remove Guardrail
0281	Guardrail	150			Guardrail
0881	Remove W Beam-S	81.5			Remove W Beam-S
0285	Guardrail-Steel Face BR	100			Guardrail-Steel Face BR
0299	Armored Edge	62			Armored Edge
0851	Steel Reinforcement	11,200			Steel Reinforcement
0851	Steel Reinforcement	190			Steel Reinforcement
0851	Steel Reinforcement	190			Steel Reinforcement
2274	Epoxy Infection Crack Repair	8			Epoxy Infection Crack Repair
0651	Pave Striping-Thermofly	150			Pave Striping-Thermofly
2378C	Concrete Sealing	245			Concrete Sealing
0860	Structural Steel	433			Structural Steel
2380C	Bearing Pads	25			Bearing Pads
0800	Concrete Patching Class "A"	25			Concrete Patching Class "A"
0029	0.3B Pgd-22	8			0.3B Pgd-22
0024	0.3A Pgd-22	36			0.3A Pgd-22
0003	Crushed Stone Base	17			Crushed Stone Base
0803	Foundation Preparation	1			Foundation Preparation
0281	Guardrail-Steel W Beam-S	50			Guardrail-Steel W Beam-S
0285	Edge Key	44			Edge Key
BRIDGE TOTALS		38			

① Approximate Number of Shear Connectors = 768
② Approximate Weight of Structural Steel = 25,697 LBS.

DATE PLOTTED: 10/26/2018
USER: kyle.s.compton
FILE NAME: C:\PWORKING\0019541\5001.TITLE.DGN

LETTING DATE

CONSTRUCTION PROJECT NO.

SPECIFICATIONS: References to the Specifications are to the 2012 Edition of the Kentucky Department of Highways Standard Specifications for Road and Bridge Construction including any current supplemental specifications. All references to the AASHTO Specifications are to the 2017 AASHTO LRFD Bridge Construction Specifications, with Interims. All references to the ASTM Standards are to the current edition of the ASTM Standard Specifications, with Interims.

DESIGN LOAD AND METHOD: This superstructure is designed for a KY-HL93 Live Load. The KY-HL93 Live Load is arrived at by increasing the standard HL93 load as specified in the AASHTO Specifications by 25%. All members are designed by the LRFD method as specified in the current AASHTO Specifications.

FUTURE WEARING SURFACE: The superstructure includes an allowance of 15 psf for a future wearing surface.

MATERIALS FOR DESIGN SPECIFICATIONS:
 For Class A Concrete: F'C = 3,500 psi
 For Class AA Concrete: F'C = 4,000 psi
 For Class M Concrete: F'C = 4,000 psi
 For Epoxy Coated Steel Reinforcement: F_y = 60,000 psi

The Specifications, Current Edition, as designated below shall govern the following materials furnished:

Material	Specification
Structural Steel	AASHTO M270 or ASTM A709, Grade 50W
Bolts	F3125 Grade A325
Anchor Rods	F1554, Grade 55
Grout	C107

All steel in longitudinal girders and all shapes and plates in diaphragms shall meet the longitudinal choppy V-notch toughness test applicable to fracture critical components Zone 2. Sampling and testing procedures shall be in accordance with AASHTO T243, current edition, utilizing (a) frequency testing. When plate thickness exceeds 1/2", frequency of testing shall be (b).

CONCRETE: Class 'AA' concrete is to be used throughout the superstructure. Class 'A' concrete is to be used in the abutments.

DIMENSIONS: Dimensions shown on these plans are taken from field survey data. The Contractor shall verify elevations and dimensions with field measurements prior to ordering materials. All plan dimensions are for a normal temperature of 60°F. Layout dimensions are horizontal dimensions.

VERIFYING FIELD CONDITIONS: Plan dimensions and details relative to the existing structure are subject to nominal construction variations. It shall be the Contractor's responsibility to verify such dimensions and details in the field and make the necessary approved adjustments prior to construction or ordering of materials. Such variations shall not be cause for additional compensation for a change in the scope of the work; However, the Contractor will be paid for the quantity actually furnished at the unit price bid for the work. In addition, the overrun and underrun formulas may be applied to appropriate repairs provided that the requirement of Article 104.02.02 of the Standard Specifications are satisfied.

REINFORCEMENT: Spacing of bars is from center to center of bars. Clear distance to face of concrete is 2" unless otherwise noted.

EPOXY COATED REINFORCING STEEL: Epoxy Coat all bars in accordance with Section 811.10 of the Standard Specifications for all reinforcement.

EXISTING STEEL REINFORCEMENT: The cost of cutting, bending, and cleaning existing steel reinforcement shall be incidental to the repair item being completed.

BEVELED EDGES: Bevel all exposed edges 3/4", unless otherwise noted.

STAY-IN-PLACE METAL FORMS: The use of stay-in-place metal formwork for the bridge deck is permitted provided the corrugations are filled with Styrofoam.

MILL TEST REPORTS: Notarized mill test reports shall be furnished in triplicate to the department showing that all structural steel conforms to the requirements of the Specifications.

WELDING SPECIFICATIONS: All welding and welding materials except for reinforcement shall conform to "Joint Specification ANSI/AASHTO AWS D1.5-2015 Bridge Welding Code". Modification and additions as stated on the plans shall supersede the Joint Specifications.

PROHIBITED FIELD WELDING: Except where shown in the plans, no welding of any nature shall be performed on the load carrying members of the bridge without the written consent of the Engineer, and then only in the manner and at the locations designated in the authorization.

WELDING REINFORCEMENT: The welding and welding material shall conform to the "Recommended Practices for Welding Reinforcing Steel", American Welding Society Specifications, Current Edition. No direct payment shall be made for welding or weld material, but the cost of these items shall be included in the unit price bid for the repair being completed.

WELDING PROCEDURES: Qualification test of all welding procedures, when required by AWS, shall be completed by the Contractor and approved by the Engineer prior to the final approval of the shop drawings and the start of the fabrication.

WELD SIZES: Unless specified otherwise, use the following fillet weld sizes:

Material Thickness of Thicker Part, Joined (In.)	Minimum Size of Fillet Weld (In.)
To 1/4" Inclusive	3/8"
Over 1/4" to 1/2"	3/8"
Over 1/2" to 3/4"	1/2"
Over 3/4"	3/4"

HIGH STRENGTH BOLT CONNECTIONS: Unless otherwise specified on the Plans, all bolted connections shall be ASTM F325 A325 11 diameter high strength bolts, nuts, and washers. Open holes shall be 1/8" larger than the diameter of the bolts. Furnish Type 3 Weathering Steel bolts as described in ASTM M164. All high strength bolted field connections are to be installed using 'direct tension indicators' (DTI's) in accordance with the Standard Specifications and ASTM F959. All DTI's shall be mechanically zinc coated. Installation details of the DTI's shall be shown on the shop plans.

SHEAR CONNECTORS: Provide the necessary length to penetrate at least 2" above bottom of slab. Stud lengths shall not be less than 5/2". Provide a minimum cover of 2/2" from the top of the deck to the top of the shear connector.

Studs shall be welded in accordance with AWS Specifications. A minimum base metal preheat temperature of 400°F is required. Preheat shall be controlled by the use of temperature indicating crayons.

PAINTING DAMAGED AREAS: All areas of new or existing structural steel on which the paint has been damaged by the Contractor shall be cleaned and spot painted to the satisfaction of the Engineer and in accordance with the Special Note for painting structural steel repairs. The cost of this touch-up is to be incidental to the contract.

DISPOSAL OF MATERIALS: All materials and debris removed from or beneath the bridge shall become the property of the Contractor and shall be removed from the right-of-way.

CONSTRUCTION IDENTIFICATION: The names of the Prime Contractor and the Sub-Contractor shall be imprinted in the concrete with 1" letters at a location designated by the Engineer. The Contractor shall furnish all plans, equipment, and labor necessary to do the work for which no direct payment will be made.

STABILITY OF THE STRUCTURE: The Contractor is completely responsible for the stability of the structure from the time of mobilization until after the bridge has been reopened to normal traffic following completion of all work required in the contract.

DAMAGE OUTSIDE CONSTRUCTION LIMITS: Any area that is disturbed outside of the limits of the construction during the life of the project shall be repaired by the Contractor at his expense, should any damage result from the Contractor's actions.

DAMAGE TO THE STRUCTURE: The Contractor shall bear full responsibility and expense for repair of any and all damage to the structure, should such damage result from the Contractor's actions. After completion of all operations, the structure and site shall be left in a condition that is in accordance with Section 105.12 of the Specifications.

CONSTRUCTION LOAD: The Contractor shall abide by the bridge posting limits. Storage of material on the bridge is prohibited.

DATE	10/25/2018	CHECKED BY	J. Pieterse
DESIGNED BY	S. Jettley	DETAILED BY	K. Melchirry
Commonwealth of Kentucky DEPARTMENT OF HIGHWAYS			
FLEMING BRIDGE			
ROUTE KY 111			
BRANCH OF HILLSBORO CREEK			
GENERAL NOTES			

BRIDGE NUMBER	035B0018N
---------------	-----------

PREPARED BY
AECOM

BRIDGING KENTUCKY

 27835

SUBSTRUCTURE PROTECTION : The contractor shall protect the substructure from staining during construction, any concrete staining will be removed prior to applying any sealing. The cost of protecting the substructures shall be included in the lump sum bid for structural steel.

CLEANING AND PAINTING: Structural steel is to be painted in accordance with Section 607.03.23 of the Specifications. Contractors are hereby reminded that in accordance with Section 607.03.23, all steel surfaces to be painted, including exposed surfaces of connection plates, nuts, bolts, and washers, shall be blast cleaned to a near white condition in accordance with SSPC-SP10 immediately prior to being painted with the first coat of paint. All structural steel is to receive the first coat of paint (Prime Coat) in the shop prior to shipping. The Contractor is responsible for maintaining the first coat of paint throughout erections to prevent staining of the substructure. The Contractor will be responsible for removing any rust staining on the substructure due to failure to maintain the first coat.

FOUNDATION PREPARATION: Backfill within 3'-0" of the back face of the abutments shall be Structure Granular Backfill, incidental to Foundation Preparation.

APPROACH PAVEMENT: Backfilling, milling, removing existing pavement, reconstructing shoulders as needed and tack coat shall be incidental to the asphalt courses.

PAYMENT FOR STRUCTURAL STEEL: The lump sum bid for structural steel shall be full payment for all structural steel, bolts, washers, welding and welding materials, and all labor and materials necessary to erect the steel in accordance with the Plans and Specifications. The approximate weight of the structural steel shown in the estimate of quantities does not include overrun or weld material. Shop cambering of steel beams will not be required. Place beams with natural camber up.

MILL TEST REPORTS: Notarized mill test reports shall be furnished in triplicate to the Department, showing that all material used in the structural steel conform to the requirements of the specifications.

IDENTIFICATION MARKING OF STEEL MEMBERS: Steel mill and fabricator identification markings for steel plates, shapes, or fabricated members shall be by metal tags, soapstone, or some other readily removable material, or shall be marked in an area of the completed member which will be encased or covered with concrete. Marking methods and locations are subject to approval of the Engineer.

Paint or wax based crayons shall not be used for marking.

HANDLING AND STORING OF STEEL MEMBERS: Steel members must not be gouged, dented, or allowed to rub against other members which would result in damage to the blast cleaned profile of the steel. Members shall be handled using softeners and slings instead of chokers and chains.

Members shall be stored in the fabrication shop or on the project site in such a manner as to be kept free and clean of all foreign substances such as grease, oil, mortar, concrete, chalk, crayon, paint, and dirt. All storage must be above ground and sloped to allow free drainage of melted snow, rainwater, and dew.

If stored for periods longer than three months, the members must be placed on metal supports. For periods of storage up to three months, members may be placed on clean, unirradiated, wood timbers. Plate girders shall be stored with the web in the upright position.

Treated lumber or timber shall not be allowed to come in contact with the steel members.

JOINT WATERPROOFING AT ABUTMENTS: The joint between the abutment seats and superstructure and between the abutment wings and superstructure shall be waterproofed as detailed on these plans.

Mastic Tape used to seal joints shall meet the requirements of ASTM C-877 Type I, II, or III. The joint is to be covered with 1/2-inch wide mastic tape. Prior to application, the joint surface shall be clean and free of dirt, debris, or deleterious material. Primer, if required by the tape manufacturer, shall be applied for a minimum width of nine inches on each side of the joint.

Mastic Tape shall be either:

- EZ-WRAP RUBBER by PRESS-SEAL GASKET CORPORATION,
- SEAL WRAP by MAR MAC MANUFACTURING CO. INC.,
- CADILLOC by UP RUBBER CO. INC.
- or an approved equivalent.

Mastic Tape shall cover the joint continuously unless otherwise shown in the plans. Mastic Tape shall be spliced by lapping a minimum of six inches and in accordance with the manufacturer's recommendations with the overlap running downhill.

The cost of this work, including all materials, labor, equipment, tools and incidentals necessary for furnishing and installing Mastic Tape shall be considered incidental to the unit price bid for Concrete Class 'AA' and no separate measurement or payment shall be made.

REMOVE SUPERSTRUCTURE: This item includes removal of the existing reinforced concrete beam and slab deck with asphalt overlay and steel railing. Payment at the contract unit price is full compensation for removing and disposing of specified existing materials, labor, equipment, tools and incidentals necessary to complete this work.

STAKING: Any staking required in the project is incidental to Class AA Concrete.

GUARDRAIL: All preparation work, including any excavation, grading, embankment in place, DGA, or other work necessary to install the approach guardrail and end treatments will be incidental to the specific pay item for guardrail or end treatment.

REVISION	DATE
DESIGNED BY: S. Jetley	CHECKED BY: J. Pieterse
DETAILED BY: K. Melchirry	J. Pieterse
Commonwealth of Kentucky	
DEPARTMENT OF HIGHWAYS	
STATE OF KENTUCKY	
FLEETING	
ROUTE KY 111	BRANCH OF HILLSBORO CREEK
GENERAL NOTES	
PREPARED BY:	
AECOM	
SHEET NO. 27835	

BRIDGE NUMBER
035B00018N

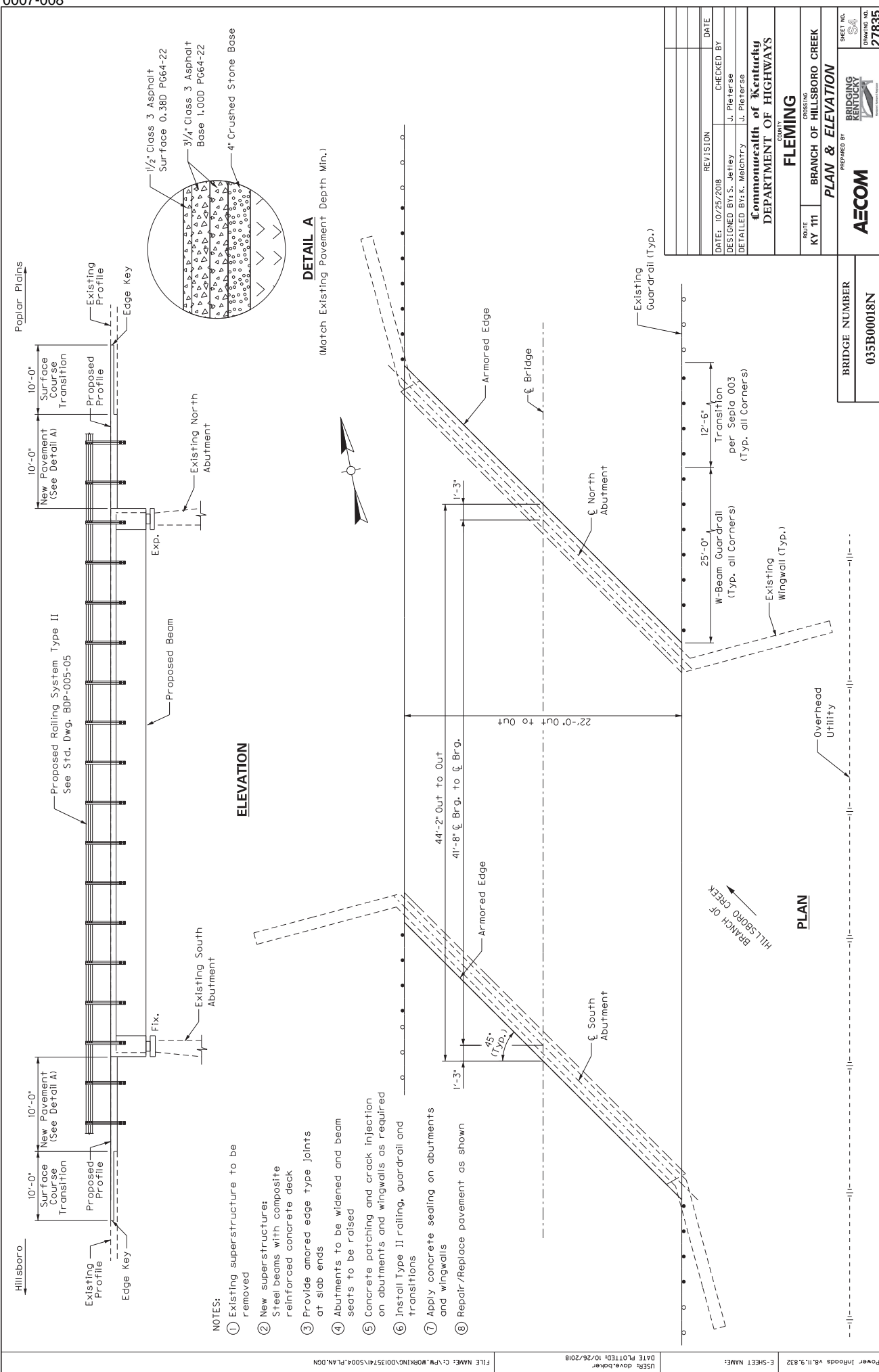

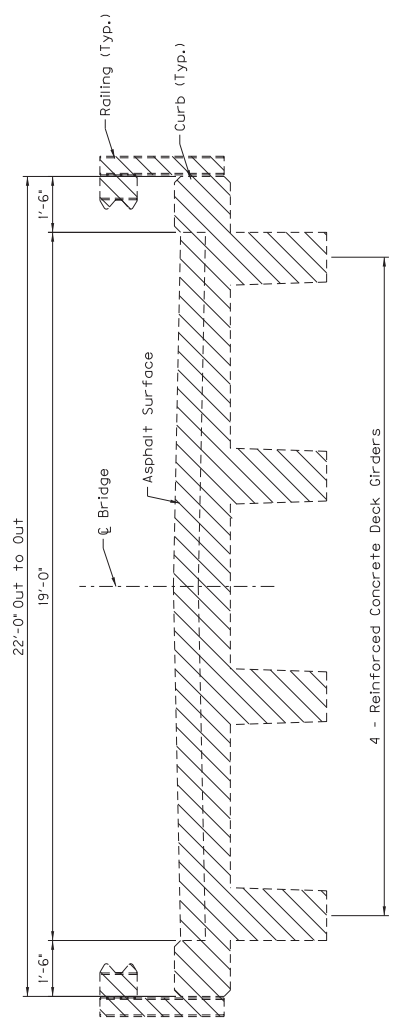

Indicates Removal Area

EXISTING TYPICAL SECTION

Existing superstructure to be removed.

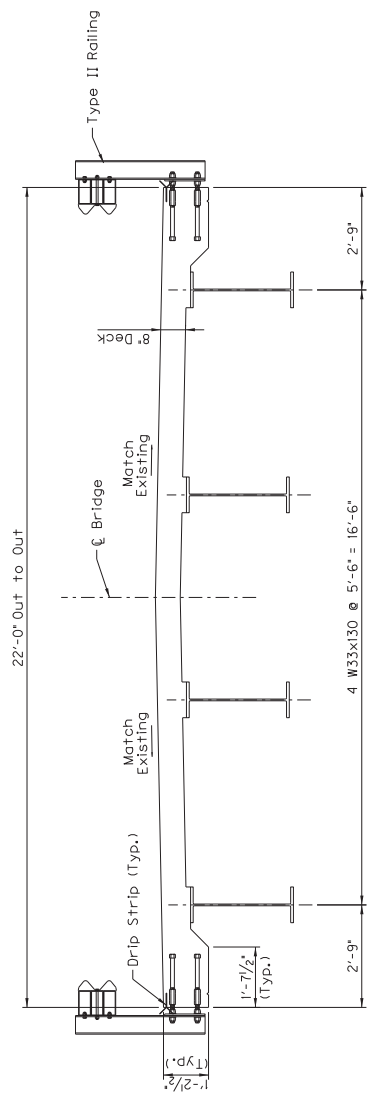

PROPOSED TYPICAL SECTION

REVISION	DATE
CHECKED BY J. Pieterse	DATE 10/25/2018
DESIGNED BY S. Jeffrey	DRAWN BY K. Weichtry
Commonwealth of Kentucky DEPARTMENT OF HIGHWAYS	
FLEMING BRANCH OF HILLSBORO CREEK TYPICAL SECTION	
ROUTE KY 111	PREPARED BY AECOM
SHEET NO. 27835	

BRIDGE NUMBER 035B00018N

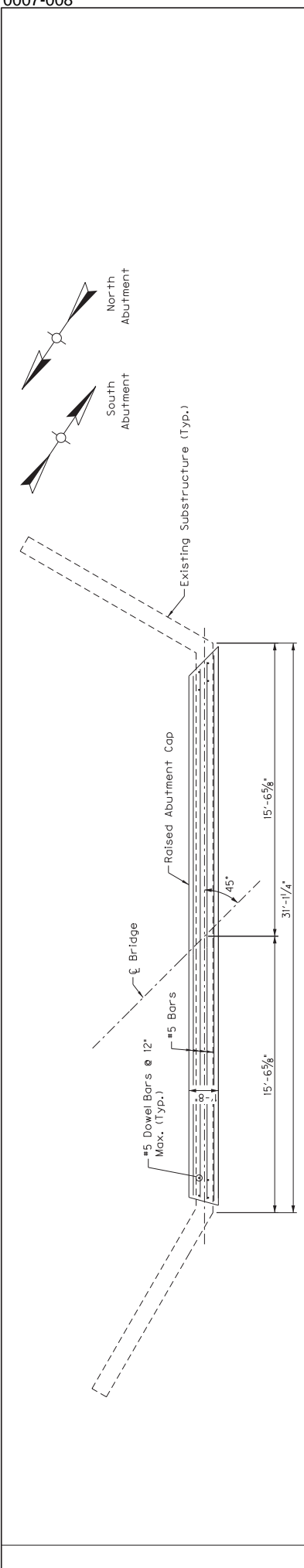

LEGEND
 Approximate Limits of Concrete Patching

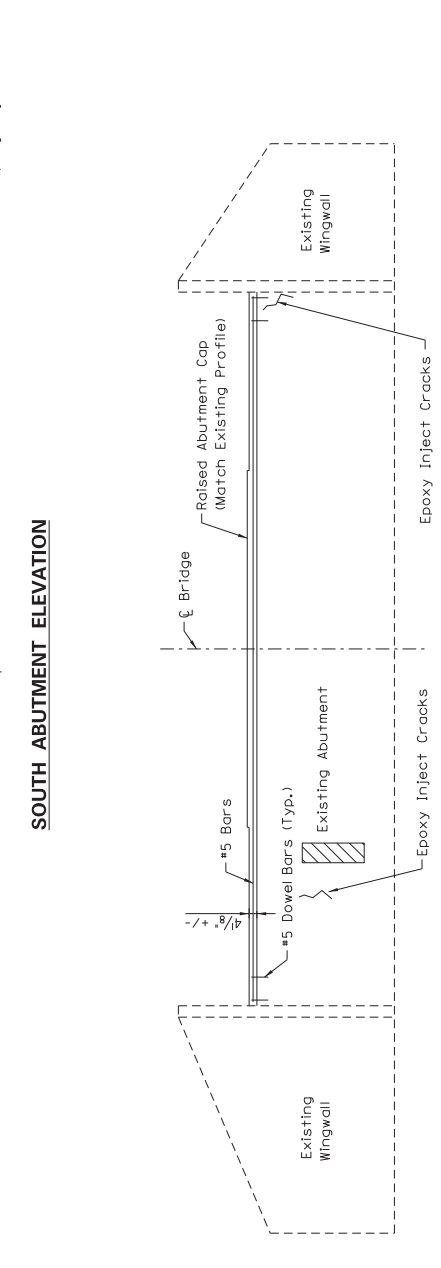
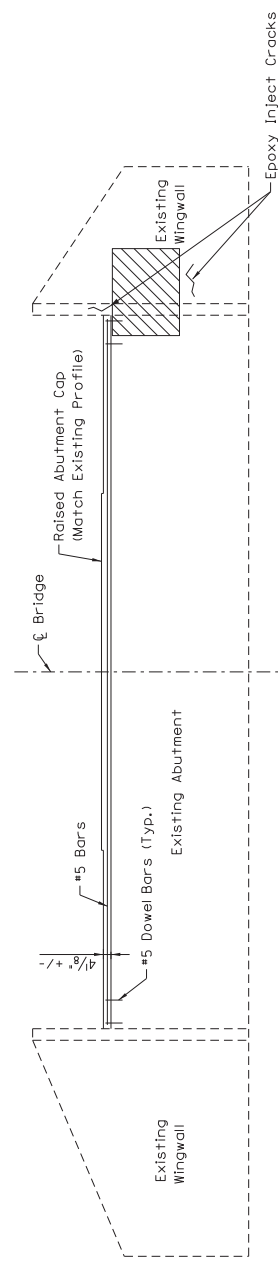

NOTES
 1. Patch Abutments and Wingwalls as directed by Engineer. Limits shown on plans are approximate and shall be field verified.
 2. See Sheet S9 for additional Abutment details.

REVISION	DATE
DESIGNED BY: S. Jeffrey	CHECKED BY: J. Pieterse
DETAILED BY: K. Melchior	J. Pieterse
Commonwealth of Kentucky DEPARTMENT OF HIGHWAYS	
FLEMING	
BRIDGE OF HILLSBORO CREEK	
ROUTE	KY 111
ABUTMENT DETAILS	
PREPARED BY:	
AECOM	
SHEET NO. 27835	

BRIDGE NUMBER	035B00018N
---------------	------------

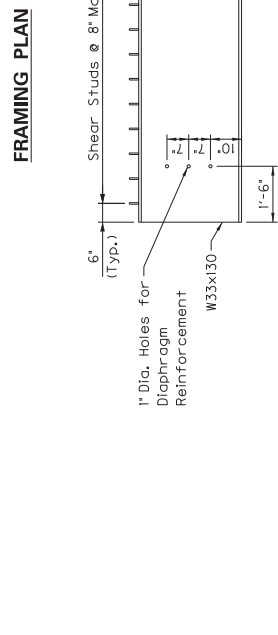
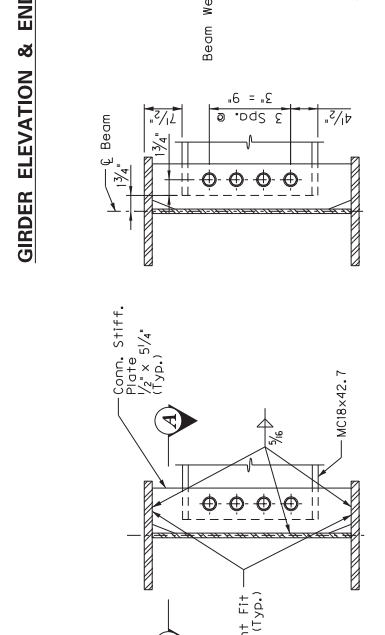
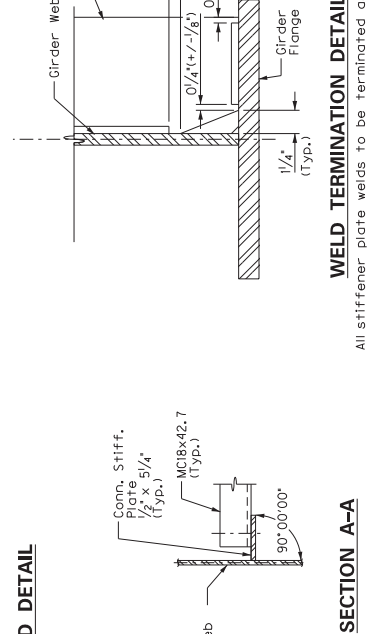
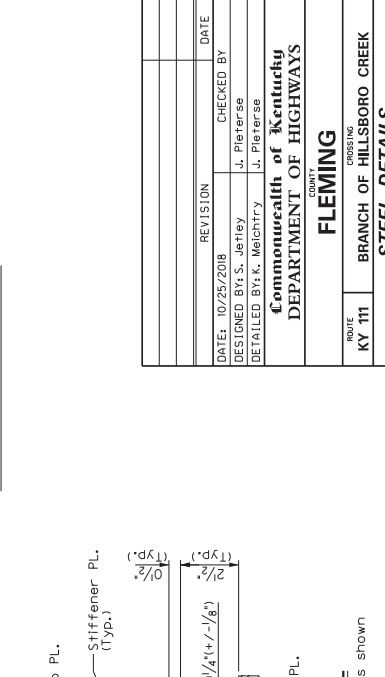
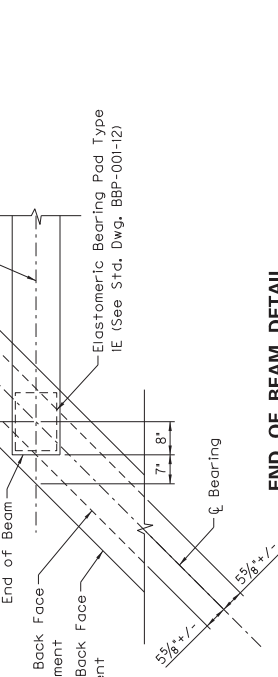
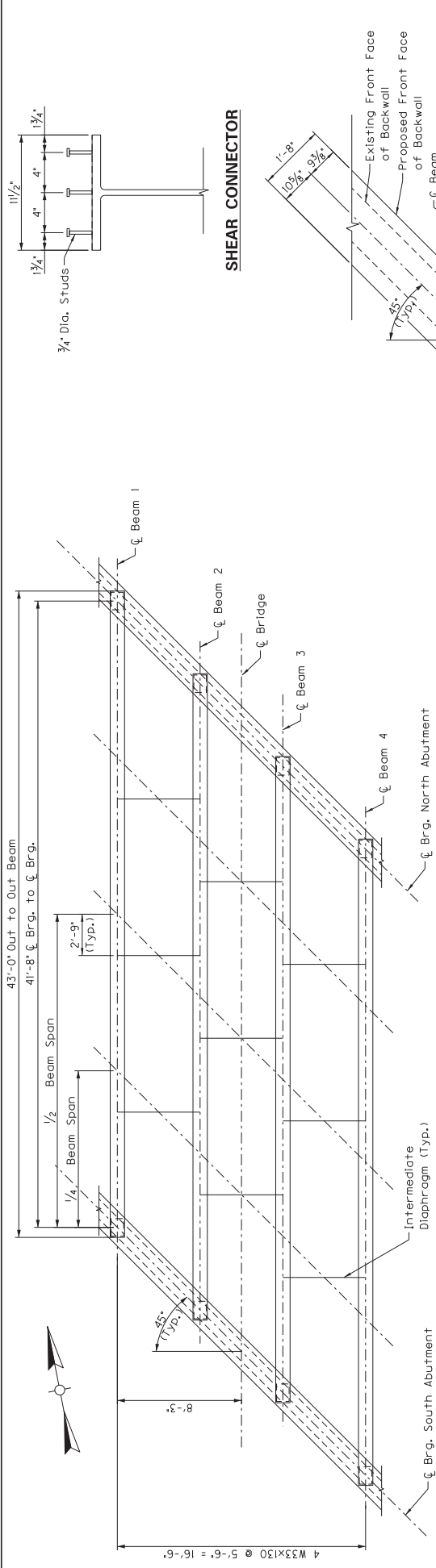

REVISION	DATE
CHECKED BY	J. Pieterse
DESIGNED BY	S. Jeffrey
DETAILED BY	K. Weichtry
Commonwealth of Kentucky DEPARTMENT OF HIGHWAYS	
FLEMING	
ROUTE	BRANCH OF HILLSBORO CREEK
KY 111	
PREPARED BY AECOM	
SHEET NO. BRIDGING KENTUCKY 27835	

BRIDGE NUMBER	035B00018N
---------------	------------

DATE PLOTTED: 10/26/2018
USER: Kimberly.Weichtry
FILE NAME: C:\PW\WORKING\00193514\15007_STEELDETAILS.DGN

E-SHEET NAME: 185013_035B00018N_16

NOTES
1. Reinforce acute slab corners per Exhibit 315 of the KYTC Structure Guidance Manual

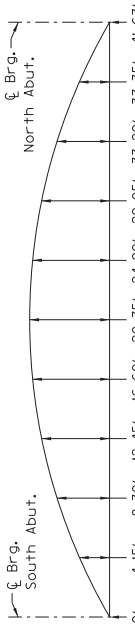
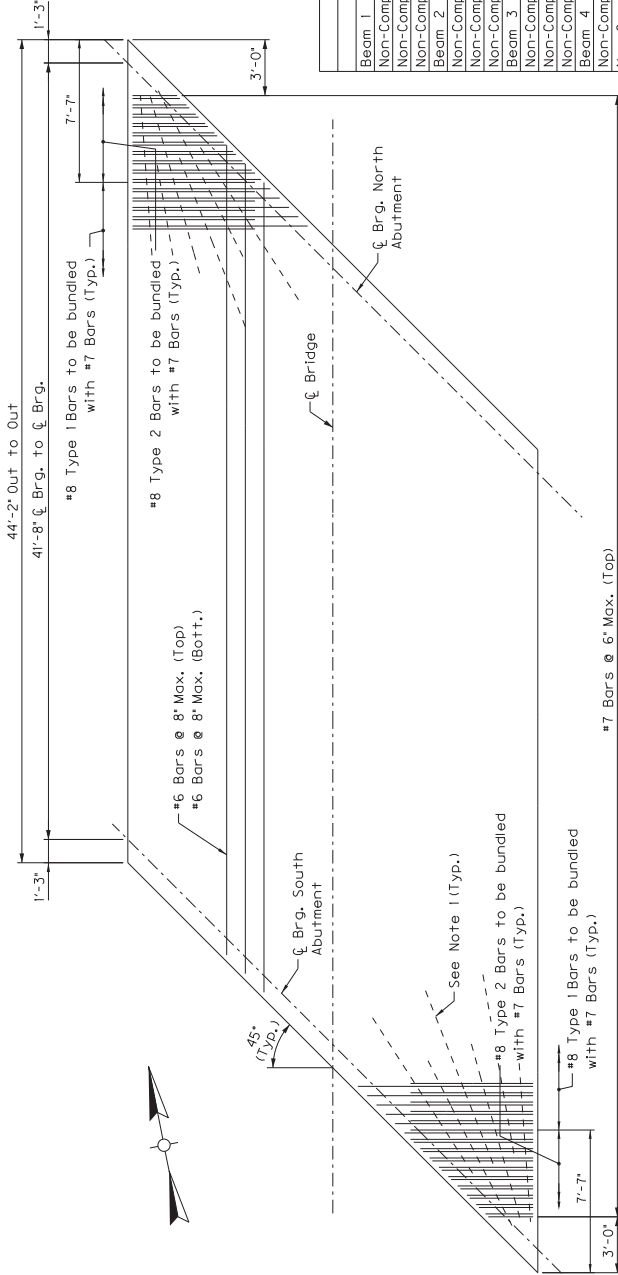

DEFLECTION FOR SLAB CONSTRUCTION

Beam 1	0'	4.15'	8.30'	12.45'	16.60'	20.75'	24.90'	29.05'	33.20'	37.35'	41.67'
Non-Comp. Dead Steel Only	0	0	1/16	1/16	1/16	1/16	1/16	1/16	1/16	1/16	0
Non-Comp. Dead Slab Only	0	1/8	3/16	1/4	1/4	3/8	1/2	3/8	1/4	1/8	0
Non-Comp. Dead Total	0	1/8	1/4	5/16	3/8	5/8	3/4	5/8	3/8	1/4	0
Beam 2	0	0	1/16	1/16	1/16	1/16	1/16	1/16	1/16	1/16	0
Non-Comp. Dead Steel Only	0	0	1/16	1/16	1/16	1/16	1/16	1/16	1/16	1/16	0
Non-Comp. Dead Slab Only	0	1/8	3/16	1/4	1/4	3/8	1/2	3/8	1/4	1/8	0
Non-Comp. Dead Total	0	1/8	3/16	1/4	3/8	5/8	3/4	5/8	3/8	1/4	0
Beam 3	0	0	1/16	1/16	1/16	1/16	1/16	1/16	1/16	1/16	0
Non-Comp. Dead Steel Only	0	0	1/16	1/16	1/16	1/16	1/16	1/16	1/16	1/16	0
Non-Comp. Dead Slab Only	0	1/8	3/16	1/4	1/4	3/8	1/2	3/8	1/4	1/8	0
Non-Comp. Dead Total	0	1/8	3/16	1/4	3/8	5/8	3/4	5/8	3/8	1/4	0
Beam 4	0	0	1/16	1/16	1/16	1/16	1/16	1/16	1/16	1/16	0
Non-Comp. Dead Steel Only	0	0	1/16	1/16	1/16	1/16	1/16	1/16	1/16	1/16	0
Non-Comp. Dead Slab Only	0	1/8	3/16	1/4	1/4	3/8	1/2	3/8	1/4	1/8	0
Non-Comp. Dead Total	0	1/8	3/16	1/4	3/8	5/8	3/4	5/8	3/8	1/4	0

#7 Bars @ 6" Max. (Top)
#7 Bars @ 8" Max. (Bottom)
#8 Type 1 & 2 Bars @ 6" Max. (In Overhangs)

DECK PLAN

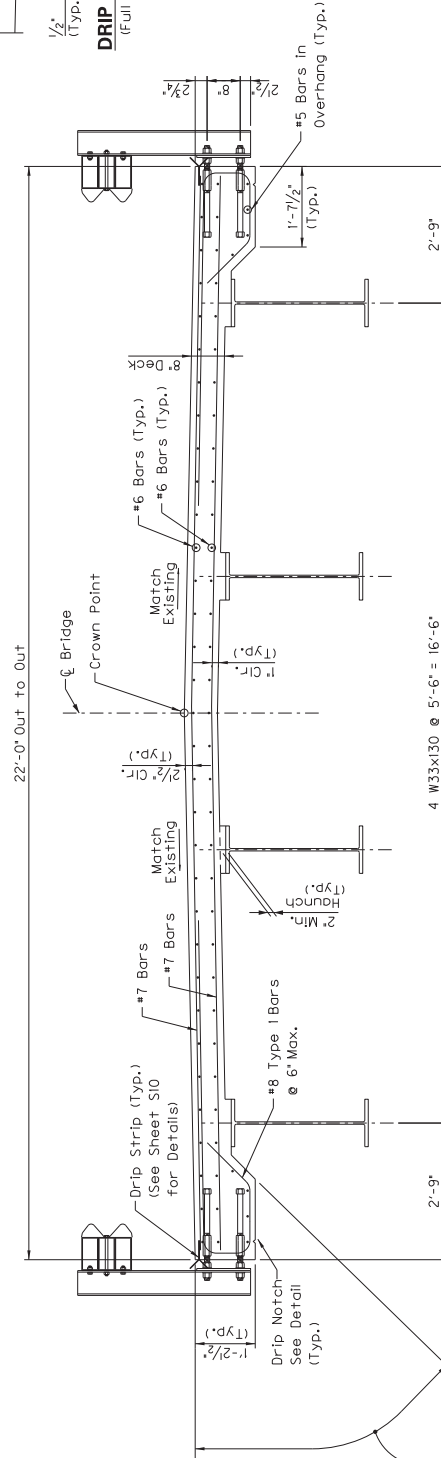
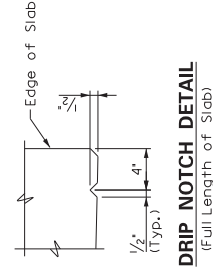

TYPICAL SECTION

REVISION	DATE
DESIGNED BY: S. Jeffrey	CHECKED BY: J. Pieterse
DETAILED BY: K. Melchirry	J. Pieterse
Commonwealth of Kentucky DEPARTMENT OF HIGHWAYS	
FLEMING	
BRIDGE OF HILLSBORO CREEK	
ROUTE	BRIDGE NUMBER
KY 111	035B00018N
AECOM	
PREPARED BY: FLEMING	
BRIDGE NUMBER: 035B00018N	
SHEET NO. 27835	

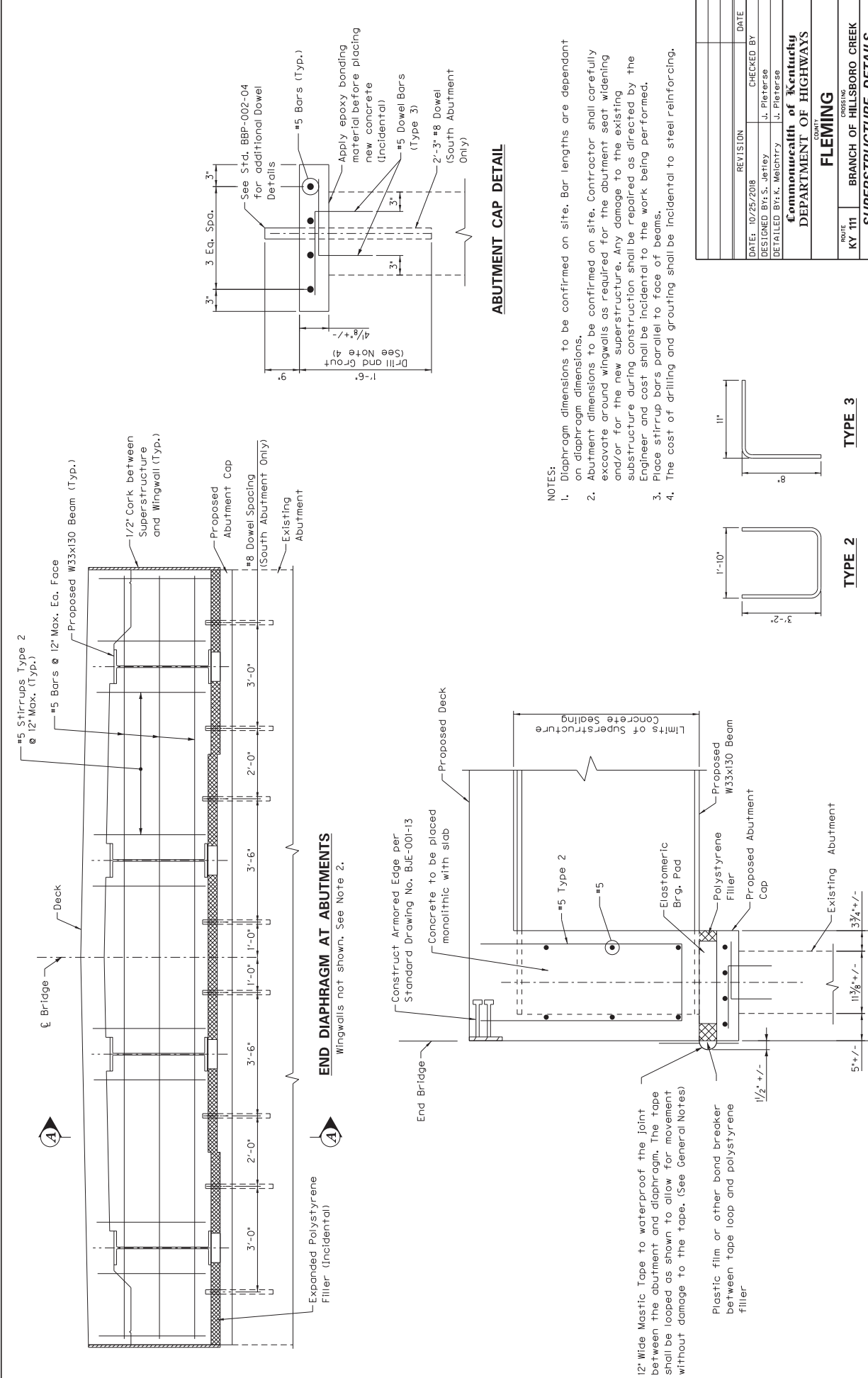

ABUTMENT CAP DETAIL

- NOTES:
1. Diaphragm dimensions to be confirmed on site. Bar lengths are dependant on diaphragm dimensions.
 2. Abutment dimensions to be confirmed on site. Contractor shall carefully excavate around wingwalls as required for the abutment seat widening and/or for the new superstructure. Any damage to the existing substructure during construction shall be repaired as directed by the Engineer and cost shall be incidental to the work being performed.
 3. Place stirrup bars parallel to face of beams.
 4. The cost of drilling and grouting shall be incidental to steel reinforcing.

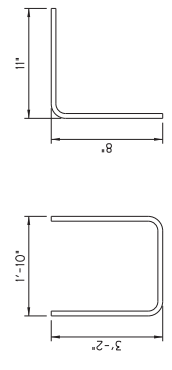

TYPE 2
TYPE 3

SECTION A-A

See Abutment Cap Detail for Additional Details

BRIDGE NUMBER
 035B00018N

REVISION	DATE
DESIGNED BY: S. Jetley	CHECKED BY: J. Pieterse
DATE: 10/25/2018	DETAILED BY: K. Melchior
Commonwealth of Kentucky DEPARTMENT OF HIGHWAYS	
BRIDGING KENTUCKY	
ORDERING BRANCH OF HILLSBORO CREEK	
ROUTE KY 111	
PREPARED BY: AECOM	
SHEET NO. 27835	

DRIP STRIP NOTES

1. Install lower stainless steel drip strip, as detailed, along the full length of each side of the bridge. If splices are required in the lower drip strip, tightly butt the individual pieces together, do not lap. Install a 1'-6" long upper drip strip at each railing post. Bend up strips at 90° against the inside face of the forms before concrete is placed. After the forms are removed, bend the drip strips into the final position of 45° as shown herein.
2. Stainless steel shall be a minimum of 22 gage ASTM A167, Type 304, mill finish.
3. Use care when stripping formwork so as not to damage or wrinkle the stainless steel drip strip. To further ensure that wrinkling of the strips does not occur, use an adequate length backup bar during the bending out operation.
4. Cost of all work, including all materials, labor, equipment, tools, and incidentals necessary, shall be considered incidental to Class 'AA' Concrete

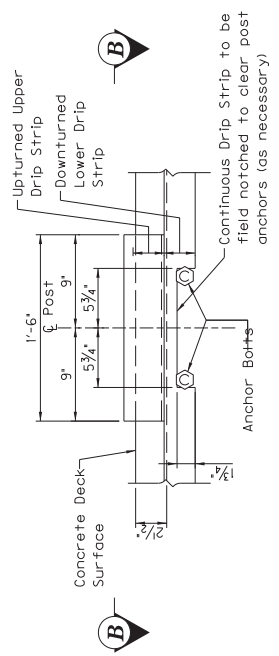

VIEW A-A

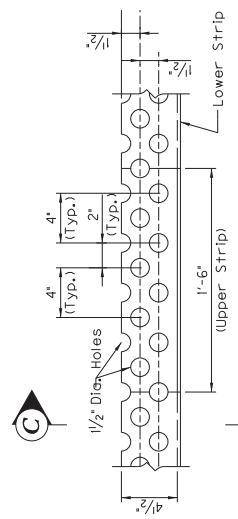

VIEW B-B

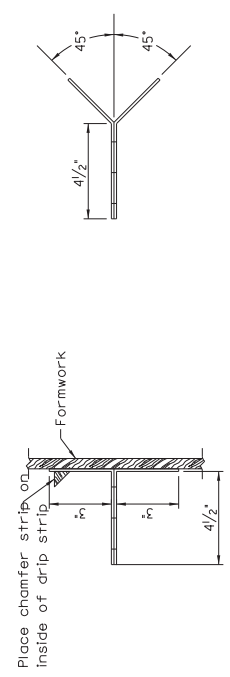

SECTION C-C
(After Concrete Placement)

SECTION C-C
(Prior to Concrete Placement)

REVISION	DATE
DESIGNED BY: S. Jeffrey	CHECKED BY: J. Pieterse
DETAILED BY: K. Weichtry	J. Pieterse
Commonwealth of Kentucky DEPARTMENT OF HIGHWAYS	
FLEMING	
ROUTE	BRANCH OF HILLSBORO CREEK
KY 111	DRIP STRIP DETAILS
PREPARED BY: AECOM	
SHEET NO. S10 OF 27835	

BRIDGE NUMBER	035B00018N
---------------	------------

09-10005 Fleming County

PLAN SHEETS

PLAN SHEETS WHICH ARE TO SCALE ARE AVAILABLE TO VIEW AND PRINT IN THE PROJECT-RELATED INFORMATION FOLDER FOR THIS LETTING AT THE CONSTRUCTION PROCUREMENT WEBSITE:

<http://transportation.ky.gov/Construction-Procurement/Pages/default.aspx>

SPECIAL NOTE FOR TRAFFIC CONTROL ON BRIDGE REPAIR CONTRACTS

035B00018N Fleming County

I. TRAFFIC CONTROL GENERAL

Except as provided herein, traffic shall be maintained in accordance with the 2012 standard specifications, section 112. The contractor will be responsible for developing and implementing the maintenance of traffic details with guidance through standard drawings and the MUTCD current editions. The developed traffic control plan must be approved by the Engineer prior to implementation. The contractor is expected to provide at a minimum the items listed in this note, however this note does not relieve the contractor of other items that may be necessary to comply with current standards. Except for the roadway and traffic control bid items listed, all items of work necessary to maintain and control traffic will be paid at the lump sum bid price to "Maintain and Control Traffic".

Contrary to section 106.01, traffic control devices used on this project may be new or used in new condition, at the beginning of the work and maintained in like new condition until completion of the work.

The contractor is allowed to close the bridge to traffic in order to complete the work for a total of 45 calendar days. The contractor must notify the engineer and public information officer at least 14 calendar days prior to the planned closure. Please see the Special Note for Liquidated Damages for additional information.

II. TRAFFIC COORDINATOR

Furnish a traffic coordinator as per section 112. The traffic coordinator shall inspect the project maintenance of traffic, at least three times daily, or as directed by the engineer, during the contractor's operations and at any time a lane closure or road closure is in place. The personnel shall have access on the project to a radio or telephone to be used in case of emergencies or accidents. The traffic coordinator shall report all incidents throughout the work zone to the engineer on the project. The contractor shall furnish the name and telephone number where the traffic coordinator can be contacted at all times.

III. SIGNS

The contractor is responsible for all signage during construction. The contractor shall adhere to the standard drawings and manual on uniform traffic control devices (MUTCD) for guidance. If, at any time, the engineer requests a change in the maintenance of traffic signage, the contractor shall implement the change within 8 hours. Failure to implement these changes within the required eight hours will result in liquidated damages of \$5,000 per day.

The contractor shall provide all detour signing needed for the bridge closure. All signing required will be incidental to the lump sum bid item "Maintain and Control Traffic".

The department will not measure installation, maintenance, or removal for payment of any detour signage or standard construction signage, and will consider these incidental to "Maintain and Control Traffic"

Closure signs and detour signs should be placed no sooner than two weeks prior to the closing of the bridge. Wayfinding detour signs should be placed a maximum of 2 miles apart unless specified by the engineer. Signs shall be covered or removed within 24 hours of opening the bridge to traffic.

Road closed signs should be double signed and placed a minimum of 1500', 1000', and 500' in advance of the closure, in addition to signage required by the MUTCD and standard drawings.

IV. TEMPORARY PAVEMENT STRIPING

It is not anticipated that temporary pavement striping will be needed since the bridge will be closed. However, if the contractor's means and methods allows for need for temporary striping, conflicting pavement marking will be covered with 6" black removable tape. Contrary to the standard specifications, no direct payment will be made for any temporary striping, pavement striping removal, or any other temporary striping item. If temporary striping is used, the contractor shall replace any temporary striping that becomes damaged or fails to adhere to the pavement before dark on the day of the notification. Liquidated damages shall be assessed to the contractor at a rate of \$500 per day for failing to replace temporary striping within this time limit.

V. PROJECT PHASING & CONSTRUCTION PROCEDURES

Project phasing shall be as directed by the plans, special notes, and the approved Traffic Control Plan prepared by the contractor. Maintain traffic over the bridge as long as possible. Once the structure is closed ensure work progresses to minimize the effected time to the public. All materials that must be made specific for the project should be ordered and made prior to closure of the bridge so that delivery does not delay the reopening, unless approved by the Engineer. If the bridge is reopened prior to safety devices being in place, an approved protective barrier wall shall be placed in accordance to the standard drawings. Contrary to standard specifications, no direct payment would be made for the barrier wall and will be considered incidental to "Maintain and Control Traffic".

VI. PAVEMENT DROP-OFF

Less than two inches - no protection required. Warning signs should be placed in advance and throughout the drop-off area.

Two to four inches - plastic drums, vertical panels or barricades every 100 feet on tangent sections for speeds of 50 mph or greater. Cones may be used in place of plastic drums, panels and barricades during daylight hours. For tangent sections with speeds less than 50 mph and curves devices should be placed every 50 feet. Spacing of devices on tapered sections should be in accordance with the manual on uniform traffic control devices, current edition.

Greater than four inches - positive separation or wedge with 3:1 or flatter slope needed. If there is five feet or more distance between the edge of the pavement and the drop-off, then drums, panel, or barricades may be used. If the drop-off is greater than 12 inches, positive separation is strongly encouraged. If concrete barriers are used, special reflective devices or steady burn lights should be used for overnight installations.

For temporary conditions, drop-offs greater than four inches may be protected with plastic drums, vertical panels or barricades for short distances during daylight hours while work is being done in the drop-off area.

VII. VARIABLE MESSAGE SIGNS

The contractor is expected to provide up to four (4) message boards for use at locations determined by the engineer. These message boards are expected to be in place one week prior to the closure of the roadway and remain in place for the duration of the closure. Contrary to the standard specification, no direct payment will be made for variable message signs. These signs will be considered incidental to the lump sum bid item "Maintain and Control Traffic".

VIII. BARRICADES AND BARRIER WALL

During closure of the bridge, ensure a minimum of (4) type III barricades are used at each end of the bridge for a total of (8) type III barricades. Contrary to the standard specifications, no direct payment will be made for barricades but they will be included in the lump sum price for "Maintain and Control Traffic".

VIII. DETOUR

The traffic control plan proposed by the contractor shall include a signed detour route for the road closure. The traffic control plan along with the proposed detour plan will be delivered to the engineer at the pre-construction meeting. The proposed detour route shall meet the following requirements:

- 1) Detour routes must remain at minimum on the same classification of roadway (i.e. AA, AAA, state, county, etc.) Unless written approval is obtained through the owner of the facility.
- 2) The contractor must coordinate with other projects along the detour route in order to avoid ongoing construction projects along those routes.
- 3) Signed detour routes must be on roadways with similar roadway characteristics, i.e. pavement widths and roadway striping.
- 4) It may be determined that two detour routes would be needed if the first selected route cannot accommodate truck traffic. If this occurs, the contractor is expected to sign both detours per the standard drawings and MUTCD. Additional clarification signage between the detours may be needed at points where they diverge.

The traffic control plan must be submitted and approved to allow for coordination of the public information officer with the closure notification. The public must be notified of the proposed detour route when they are notified of the closure, 2 weeks before closure. All time and expenses necessary for the development of the detour plan(s) will be incidental to the lump sum bid item "Maintain and Control Traffic".

SPECIAL NOTE FOR CONCRETE PATCHING REPAIR

These Notes or designated portions thereof, apply where so indicated on the plans, proposals or bidding instruction.

- I. DESCRIPTION.** Perform all work in accordance with the Department's 2012 Standard Specifications, and applicable Supplemental Specifications, the attached sketches, and these Notes. Section references are to the Standard Specifications.

This work consists of: (1) Furnish all labor, materials, tools, and equipment; (2) Remove existing spalled/delaminated concrete; (3) Prepare the existing surface for concrete patching; (4) Place hook fasteners and welded wire fabric over surfaces to be repaired (where applicable); (5) Apply concrete patching as specified by this note and as shown on the attached detail drawings; (6) Finish and cure the new Concrete Patches; (7) Maintain & control traffic; and, (8) Any other work specified as part of this contract.

II. MATERIALS.

- A. Class "M" Concrete.** Use either "M1" or "M2". See Section 601.
- B. Steel Reinforcement.** Use Grade 60. See Section 602
- C. Welded Steel Wire Fabric (WWF).** Conform to Section 811
- D. Hook Fasteners.** Use commercial grade galvanized hook fasteners. Minimum 3/16" diameter.

III. CONSTRUCTION.

- A. Concrete Removal and Preparation.** The Contractor, as directed by the Engineer shall locate and remove all loose, spalled, deteriorated and delaminated concrete. Sounding shall be used to locate delaminated areas. Care shall be exercised not to damage areas of sound concrete or reinforcing steel during concrete removal operations. Concrete removal shall be in accordance with a sequence approved by the Engineer.

Concrete removal shall be accomplished by chipping with hand picks, chisels or light duty pneumatic or electric chipping hammers (not to exceed 15 lbs.). Remove all deteriorated loose concrete to a minimum depth of 4". When reinforcing steel is exposed, concrete removal shall continue until there is a minimum 3/4 inch clearance around the exposed reinforcing bar. Care shall be taken to not damage bond to adjacent non-exposed reinforcing steel during concrete removal processes. Unless specifically *directed by the Engineer*, depth of removal shall not exceed 6 inches.

The perimeter of all areas where concrete is removed shall be tapered at an approximately 45° angle, except that the outer edges of all chipped areas shall be saw cut to minimum depth of 1 inch to prevent featheredging unless otherwise approved by the Engineer.

After all deteriorated concrete has been removed; the repair surface to receive concrete patching shall be prepared by abrasive blast cleaning. Abrasive blast cleaning shall remove all fractured surface concrete and all traces of any unsound material or contaminants such as oil, grease, dirt, slurry, or any materials which could interfere with the bond of freshly placed concrete.

The Contractor shall dispose all removed material off State Right Of Way in an approved site.

- B. Steel Reinforcement.** All corroded reinforcing steel exposed during concrete removal shall have corrosion products removed by abrasive grit blasting or wire brush whichever is more appropriate. Furnish for replacement, as directed by the Engineer, additional linear feet of steel reinforcing bars ½” diameter by 20-foot lengths. Place these bars in areas deemed by the Engineer to require additional reinforcement. Field cutting and bending is permitted. Deliver unused bars to the nearest County Maintenance Barn. Payment will be made in accordance with Section 602.

Reinforcing steel displaying deep pitting or loss of more than 20 percent of cross-sectional area shall be removed and replaced. Such bars shall be placed in accordance with the recommendations of ACI 506R, Sections 5.4 and 5.5. In particular, bars shall not be bundled in lapped splices, but shall be placed such that the minimum spacing around each bar is three times the maximum aggregate size to allow for proper encapsulation with concrete patching.

Intersecting reinforcing bars shall be tightly secured to each other using tie wire and adequately supported to minimize movement during concrete placement.

Welded wire fabric (WWF) shall be provided when shown on the attached sketches and at each repair area larger than 1 square foot if the depth of the repair exceeds 3 inches from the original dimension of the repaired member. Sheets of adjoining WWF shall be lapped by at least one and one-half spaces at all intersections, in both directions, and be securely fastened. WWF fabric shall be supported no closer than ½ inch to the prepared concrete surface and shall have a minimum concrete cover of 1.5 inches.

WWF shall be fastened to preset anchors on a grid not more than 12 inches square. Large knots of tie wire which could result in sand pockets and voids during patching shall be avoided.

- C. Hook Fasteners.** Hook fasteners shall be positioned at the spacing as stated above or as directed by the Engineer. Any given area shall have a minimum of four anchors. The WWF shall not move or deform excessively during concrete patching. Maximum hook fastener spacing shall not exceed 2 feet on a grid pattern over the entire repair area.

Hook fasteners shall be of commercial grade galvanized steel with a minimum diameter of 3/16". They may be mechanically set or grouted, as approved by the Engineer.

The Department will randomly select hook fasteners to be tested to verify pullout force is sufficient. If any anchors fail to meet the minimum acceptable pullout value, corrective measures shall be taken by the Contractor and further testing will be conducted.

- D. Class M Concrete.** Place and finish the new concrete for the patching area as shown on the attached detail drawings, or as directed by the Engineer. The Engineer shall approve the Contractor's method of placing and consolidating the concrete prior to the beginning of this operation.
- E. Curing.** On completion of finishing operation, patching concrete shall immediately be prevented from drying out and cracking by fogging, wetting, and/or any appropriate method approved by the Engineer. See Section 501.03.15.

Each Contractor submitting a bid for this work shall make a thorough inspection of the site prior to submitting his bid and shall thoroughly familiarize himself with existing conditions so that the work can be expeditiously performed after a contract is awarded. Submission of a bid will be considered evidence of this inspection having been made. Any claims resulting from site conditions will not be honored by the Department. Quantities given are approximate. The quantity for "Concrete Patching Repair" shall be bid with the contingency that quantities may be increased, decreased, or eliminated by the Engineer. Dispose of all removed material entirely away from the job site as approved by the Engineer. This work is incidental to the contract unit price for "Concrete Patching Repair".

IV. MEASUREMENT

- A. Concrete Patching Repair.** The Department will measure the quantity per square feet of each area restored. Double payment will not be made on both faces of corner repairs.
- B. Steel Reinforcement.** See Section 602.
- C. Welded Wire Fabric & Hook Fasteners.** Welded Wire Fabric and Hook Fasteners will not be measured for payment, but shall be considered incidental to "Concrete Patching Repair".

V. PAYMENT

- A. Concrete Patching Repair.** Payment at the contract unit price per square feet is full compensation for the following: (1) Furnish all labor, materials, tools, equipment; (2) preparation of specified areas including removing and disposing of specified existing materials; (3) place, finish, and cure new concrete patches; and (4) all incidentals necessary to complete the work as specified by this note and as shown on the attached detail drawings.
- B. Steel Reinforcement.** See Section 602.

The Department will consider payment as full compensation for all work required by these notes and detail drawings.

SPECIAL NOTE FOR EPOXY INJECTION CRACK REPAIR

I. DESCRIPTION

Perform all work in accordance with the Kentucky Transportation Cabinet, Department of Highways 2012 Standard Specifications for Road and Bridge Construction and applicable Supplemental Specifications, the Standard Drawings, this Note, and the Contract Documents. Section references are to the Standard Specifications.

This work consists of the following:

1. Furnish all labor, materials, tools, equipment, and incidental items necessary to complete the work.
2. Provide safe access to the bridge, in accordance with Section 107.01.01, for the Engineer to sound possible repair areas and for workers to complete the construction.
3. Drill injection port holes.
4. Epoxy injection.
5. Finish the repaired surface.
6. Obtain core samples for the Engineer's visual inspection.
7. Repair core holes.
8. Any other work specified as part of this contract.

II. MATERIALS, EQUIPMENT, PERSONNEL

A. Type IV Epoxy Resin. Use either Category I or II suitable for epoxy injection applications. See Section 826. All cracks shall be injected using an adhesive suitable for the field conditions (crack width, temperature, humidity, etc.) recommended by the adhesive manufacture as shown on material data sheets.

B. Equipment. Equipment used to inject the epoxy shall meet the recommendations of the epoxy injection material manufacturer.

C. Personnel. Arrange to have a manufacturer's representative at the job site to familiarize him and the Engineer with the epoxy materials, application procedures and recommended pressure practice. The representative shall direct at least one complete crack or area injection and be assured prior to his departure from the project that the personnel are adequately informed to satisfactorily perform the remaining repairs.

Furnish the Engineer a copy of the manufacturer's comprehensive preparation, mixing and application instructions which have been developed especially for use with the proposed epoxy injection system. Ensure that any significant changes to these instructions which are recommended by the representative for an unanticipated situation have been approved by the Engineer prior to the adoption of such changes.

III. CONSTRUCTION

- A. Investigate Remedial Action.** If the crack is larger than or equal to 0.025" wide or has rust stains, repair the crack by epoxy injection. If the crack is less than 0.025" wide, the crack shall be sealed in accordance with the Special Note for Concrete Sealing. Areas of map cracking are to be sounded by the Engineer with a hammer. If the areas are delaminated or spalled, they shall be repaired in accordance with the Special Note for Concrete Patching. Otherwise, the cracks shall be repaired in accordance with this Note.
- B. Drill Injection Port Holes.** Install injection ports or tees in cracks to be injected. Space injection ports or tees at 6 to 12 inches vertically and 6 to 18 inches horizontally but in no case closer together than the thickness of the concrete member if full depth penetration is desired unless otherwise specified or directed. Set ports or tees in dust free holes made either with vacuum drills or chipping hammers.
- C. Epoxy Injection.** Seal all surface cracks in the area to be repaired, after injection ports or tees have been inserted into the holes, with paste epoxy between ports to insure retention of the pressure injection within the confines of the member. An alternate procedure of sealing the cracks before the injection holes have been made can be submitted to the Engineer for approval. Limit the application of paste epoxy to clean and dry surfaces. Limit substrate temperatures to not less than 45°F during epoxy applications.
- Begin the epoxy injection at the bottom of the fractured area and progress upward using a port or tee filling sequence that will ensure the filling of the lowermost injection ports or tees first.
- Establish injection procedures and the depths and spacings of holes at injection ports or tees. Use epoxy with flow characteristics and injection pressure that ensure no further damage will be done to the member being repaired. Ensure that the epoxy will first fill the innermost portion of the cracked concrete and that the potential for creating voids within the crack or epoxy will be minimized.
- D. Finish the Repaired Surface.** Remove the injection ports or tees flush with the concrete surface after the fractured area has been filled and the epoxy has partially cured (24 hours at ambient temperature not less than 60°F, otherwise not less than 48 hours). Roughen the surfaces of the repaired areas to achieve uniform surface texture. Remove any injection epoxy runs or spills from concrete surfaces.
- E. Obtain Core Samples.** Obtain two 4-inch diameter core samples in the first 25 linear feet of crack repaired and one core for each 25 linear feet thereafter. Take the core samples from locations determined by the Engineer and for the full crack depth. Cores will be visibly examined by the Engineer to determine the extent of epoxy penetration.
- F. Repair Core Holes.** Repair core holes in the concrete with non-shrink grout in accordance with Section 601.03.03(B) within 24 hours.

IV. MEASUREMENT

The Department will measure the quantity in linear feet along the centerline of the cracks. The Department will not measure preparation of the site for the Engineer's access or removal and reapplication of repairs that do not satisfy the Engineer's approval for payment and will consider them incidental to "Epoxy Injection Crack Repair".

V. PAYMENT.

The Department will make payment for the completed and accepted quantities of concrete cracks repaired with epoxy injection under the following:

<u>Code</u>	<u>Pay Item</u>	<u>Pay Unit</u>
23744EC	Epoxy Injection Crack Repair	Linear Feet

The Department will consider payment as full compensation for all work required.

SPECIAL NOTE FOR CONCRETE SEALING

I. DESCRIPTION

Perform all work in accordance with the Kentucky Transportation Cabinet, Department of Highways 2012 Standard Specifications for Road and Bridge Construction and applicable Supplemental Specifications, the Standard Drawings, this Note, and the Contract Documents. Section references are to the Standard Specifications.

This work consists of the following:

1. Furnish all labor, materials, tools, equipment, and incidental items necessary to complete the work.
2. Provide safe access to the bridge, in accordance with Section 107.01.01, for the Engineer to sound possible repair areas and for workers to complete the construction.
3. Repair cracks as applicable in accordance with the Special Note for Epoxy Injection Crack Repair.
4. Repair delaminated or spalled areas as applicable in accordance with the Special Note for Concrete Patching.
5. Apply Ordinary Surface Finish
6. Prepare the surfaces to receive coating.
7. Apply concrete coating.
8. Any other work as specified as part of this contract.

II. MATERIALS

One of the following coating systems shall be used:

<u><i>Manufacturer</i></u>	<u><i>Prime Coat</i></u>	<u><i>Finish Coat</i></u>
Sherwin Williams	Macropoxy 646	Acrolon 218 HS
PPG	Amerlock 2	Devoe Devflex HP
Carboline	Carboguard 890	Carbothane 133 HB
Tnemec	Elastogrip 151	Envirocrete 156

The coating shall be tinted and the color shall closely match the existing concrete. The finish product shall be opaque and satin or semi-gloss. The contractor must apply sufficient coats as required to achieve this goal.

Furnish to the Engineer copies of the manufacturer's technical data sheets, installation guidelines, material safety data sheets, and other pertinent data at least two (2) days prior to beginning the work.

III. CONSTRUCTION

- A. Perform Concrete Repairs.** Repair concrete surface in accordance with the Special Note for Epoxy Injection Crack Repair and/or the Special Note for Concrete Patching Repair if included in the contract documents.

B. Apply Ordinary Surface Finish. Areas receiving epoxy injection, concrete patching, and other surface imperfections, including areas of minor cracking, should receive Ordinary Surface Finish in accordance with Section 601.03.18 of the Standard Specifications. Use mortar of the same cement and fine aggregate as the concrete patching, or as directed by the Engineer. Payment will be incidental to Concrete Sealing.

C. Areas to Receive Concrete Sealing:

- a. All exposed concrete on abutments and wingwalls.
- b. All exposed concrete on piers, including caps.

D. Prepare Concrete Surfaces for Repair. All areas specified shall be pressure washed. All equipment for pressure washing shall be operated at a minimum pressure of up 4,000 psi with 0 degree spinner tip and/or fan tips as determined by the engineer at the working location with a minimum flow rate of 3.5 gal/minute provided that these pressures do not damage any components of the structure. Pressure and flow rates shall be reduced to a level satisfactory to the Engineer should any damage occur due to power washing procedures. Pressure washing shall be operated at distance of approximately six inches from and perpendicular to the surface. All pressure washing wands shall be equipped with a gauge to accurately determine the amount pressure used. Pressure washing of any bridge element will proceed from top of wash area to bottom of wash area. Wash water will not be released to a bridge element previously washed. Perform all pressure washing at temperatures above 40 degrees Fahrenheit.

E. Apply Concrete Coating. All areas specified shall have concrete coating applied to as specified after debris removal and power washing. New concrete shall be allowed to properly cure in accordance with the manufacturer's recommendations prior to application. Use compressed air to remove any loose debris from the surfaces that are to be coated after power washing. All coatings shall be applied within manufacturers recommended dry film thickness range. Comply with KYTC "Standard Specifications for Road and Bridge Construction" Section 614.03.02 and coatings supplier recommended conditions for application. Allow the surfaces to be coated to dry before any coating is applied. The coating must be applied to a clean and dry surface. All coating application shall be executed using brushes, rollers, etc. No spray application will be permitted.

The Department requires acceptance testing of samples obtained on a per-lot basis per-shipment. The Division of Materials shall perform acceptance testing. Test samples shall be taken at the Contractor's paint storage site. Department personnel shall perform sampling. Allow (10) working days for testing and approval of the sampled paint. It is the Contractor's responsibility to maintain an adequate inventory of approved paint. The Department shall assume no responsibility for lost work due to rejection of paint or approved paint subsequently found to be defective during the application process. Perform all concrete coating application at temperatures above 40 degrees Fahrenheit or in accordance with manufactures specifications.

IV. MEASUREMENT

The Department will measure the quantity in square feet. The Department will not measure preparation of the site for the Engineer's access or removal and reapplication of coatings that do not satisfy the Engineer's approval for payment and will consider them incidental to "Concrete Sealing".

V. PAYMENT.

The Department will make payment for the completed and accepted quantities of concrete sealing under the following:

<u>Code</u>	<u>Pay Item</u>	<u>Pay Unit</u>
23378EC	Concrete Sealing	Square Foot

The Department will consider payment as full compensation for all work required as described in this note.

**SPECIAL NOTE FOR CONTRACT COMPLETION DATE AND
LIQUIDATED DAMAGES ON BRIDGE REPAIR CONTRACTS**

035B00018N Fleming County

I. COMPLETION DATE.

Upon Notice to Proceed, the Contractor has the option of selecting the Begin Work date. Once selected, notify the Department in writing of the date selected at least two weeks prior to beginning work and provide a proposed project schedule. All work is to be completed by the specified contract completion date. The Contractor is allotted 45 calendar days once the bridge is closed to complete all work to safely reopen the structure with no lane closures. At a minimum, prior to reopening the bridge to traffic, all strength requirements and curing for materials used shall be completed per Division 600 of the Standard Specifications. Guardrail shall be installed to the satisfaction of the Engineer prior to reopening the bridge to traffic unless prior approval is obtained from the engineer for use of temporary railing.

The Engineer will begin charging calendar days for a structure on the day the Contractor closes the structure to traffic, regardless of holidays or seasonal weather limitations.

II. LIQUIDATED DAMAGES.

Liquidated damages will be assessed to the Contractor in accordance with the Transportation Cabinet, Department of Highway's 2012 Standard Specifications for Road and Bridge Construction, Section 108.09, when either the allotted number of calendar days or the specified completion date is exceeded.

Contrary to the Standard Specifications, liquidated damages will be assessed to the Contractor during the months of December, January, February and March when the contract time has expired on any individual bridge. Contract time will be charged during these months. All construction must be completed in accordance with the weather limitations specified in Section 606 and/or Section 601 as applicable. No extension of Contract time will be granted due to inclement weather or temperature limitations that occur due to starting work on the Contract or a structure late in the construction season.

Any approval of cold weather plans or allowance of construction operations to occur outside Section 606 and/or Section 601 does not alleviate the 45 day maximum bridge closure. In the event the closure lasts longer than 45 calendar days as specified, liquidated damages will apply to all excess days regardless of weather limitations.

SPECIAL NOTE

Tree Clearing Restriction

Fleming County

Item No. 9-10005

Bridge No. 035B00018N

DUE TO THE RECOVEREY PLAN FOR ENDANGERED BATS, NO TREE
CLEARING IS PERMITTED FROM JUNE 1 THROUGH JULY 31.

**If there are any questions regarding this note, please contact Danny Peake,
Director, Division of Environmental Analysis, 200 Mero Street, Frankfort, KY
40601, Phone: (502) 564-7250.**

Special Note for Bridge Demolition, Renovation and Asbestos Abatement

If the project includes any bridge demolition or renovation, the successful bidder is required to notify Kentucky Division for Air Quality (KDAQ) via filing of form (DEP 7036) a minimum of 10 days prior to commencement of any bridge demolition or renovation work.

Any available information regarding possible asbestos containing materials (ACM) on or within bridges to be affected by the project has been included in the bid documents. These are to be included with the Contractor's notification filed with the KDAQ. If not included in the bid documents, the Department will provide that information to the successful bidder for inclusion in the KDAQ notice as soon as possible. If there are no documents stating otherwise, the bidders should assume there are no asbestos containing materials that will in any way affect the work.



Asbestos Inspection Report

To: Tom Springer, QK4, Inc.

Date: October 15, 2018

Conducted By: Eric Altobellis, LFI, Inc.
Kentucky Accredited Asbestos Inspector #118-07-9605

Project and Structure Identification

Project: Fleming County: Item No. 9-10005

Structure ID: #035B00018N

Structure Location: Hillsboro Road (KY-111) over unnamed tributary near Hillsboro, Fleming County, Kentucky

Sample Description: Mastic between bridge deck and abutment

Inspection Date: October 5, 2018

Results and Recommendations

The asbestos inspection was performed in accordance with current United States Environmental Protection Agency (US EPA) regulations, specifically 40 CFR Part 61, Asbestos National Emissions Standards for Hazardous Air Pollutants (NESHAP) revision, final rule effective November 20, 1990.

It is recommended that this report accompany the 10-Day Notice of Intent for Demolition ([DEP7036 Form](#)) which is to be submitted to the Kentucky Division of Air Quality prior to abatement, demolition, or renovation of any building or structure in the Commonwealth.

The results of the samples collected were negative for the presence of asbestos above 1%. No abatement is required at this time.

<b style="font-size: 1.2em;">MRS, INC. <i>MRS, Inc. Analytical Laboratory Division</i>
--

332 West Broadway / Suite # 902
Louisville, Kentucky - 40202 - 2133

(502) 495-1212
Fax: (502) 491-7111

BULK SAMPLE ASBESTOS ANALYSIS

Analysis N #	<u># 10112</u>	Address:	<u>Fleming County / # 9-1005</u>
Client Name:	<u>LFI</u>		<u>(KYTC Bridges Project # 168-18)</u>
Sampled By:	<u>Eric Altobellis</u>		

		% FIBROUS ASBESTOS				% NON-ASBESTOS FIBERS					
Sample ID	Color	Layered	Fibrous	Chrysotile	Amosite	crocidolite	Others	Cellulose	Fiberglass	Syn. Fiber	Other/Mat.
# 1 A	Black	Yes	No	3%	(To Be	Point Counted)		2%			95%
# 1 B	Black	Yes	No	3%	(To Be	Point Counted)		2%			95%

Methodology : EPA Method 600/R-93-116
 Date Analyzed : 11-Oct-18
 Analyst : Winterford Mensah

Reviewed By: 
Signature

The test relates only to the items tested. This report does not represent endorsement by NVLAP or any agency of the U.S Government. Partial Reproduction of any part of this report is strictly prohibited. Samples shall be retained for (30) days.

MRS, INC. MRS, Inc. Analytical Laboratory Division

332 West Broadway, Suite 613
Louisville, Kentucky 40202

(502) 495-1212
Fax: (502) 491-7111

Client: L F I
Address: 114 Fairfax Avenue
Louisville, Kentucky
40207
Attention : Eric Alotebellis

Project No: # 10112
Sample ID: # 1 A
Sampled: 5-Oct-18
Received: 5-Oct-18
Analyzed: 11-Oct-18 - Point Count -

Bulk Sample Analysis

Sampled by: Eric Alotebellis
Facility/Location: Fleming County / # 9 - 10005
Field Description: Mastic / Tar - Bridge Deck To Abutment Seam

Laboratory Description:
Thick Black Material

Asbestos Materials:
Chrysotile = 2/400 = 0.50 % (< 1 %) Sample Is Negative

Non-asbestos Fibrous Materials & Matrix Materials:

<u>Cellulose</u>	<u>0.25 %</u>
<u>Binders</u>	<u>99.25 %</u>

Remarks: The sample was analyzed for asbestos content following the EPA Methodology (600/R-93/116). The test relates only to the items tested. This report does not represent endorsement by NVLAP or any agency of the U.S. Government.

Analyst: Winterford Mensah

Reviewed By: 
Signature

MRS, INC. *MRS, Inc. Analytical Laboratory Division*

332 West Broadway, Suite 613
Louisville, Kentucky 40202

(502) 495-1212
Fax: (502) 491-7111

Client: L F I
Address: 114 Fairfax Avenue
Louisville, Kentucky
40207
Attention : Eric Alotebellis

Project No: # 10112
Sample ID: # 1 B
Sampled: 5-Oct-18
Received: 5-Oct-18
Analyzed: 11-Oct-18 - Point Count -

Bulk Sample Analysis

Sampled by: Eric Alotebellis
Facility/Location: Fleming County / # 9 - 10005
Field Description: Mastic / Tar - Bridge Deck To Abutment Seam

Laboratory Description:
Thick Black Material

Asbestos Materials:
Chrysotile = 2/400 = 0.50 % (< 1 %) Sample Is Negative

Non-asbestos Fibrous Materials & Matrix Materials:
Cellulose 0.25 %
Binders 99.25 %

Remarks: The sample was analyzed for asbestos content following the EPA Methodology (600/R-93/116). The test relates only to the items tested. This report does not represent endorsement by NVLAP or any agency of the U.S. Government.

Analyst: Winterford Mensah

Reviewed By: 
Signature

MRS, Inc.
332 West Broadway / Suite # 613
Louisville, Kentucky - 40202 - 2111

Phone #: (502) 495 - 1212
Fax #: (502) 491 - 7111

Client : Linebach Funkhouser, Inc.
Project : LFI Project #168-18

CHAIN OF CUSTODY RECORD

PROJECT: KYTC Bridges #168-18
LOCATION: Fleming Co. #9-10005
SAMPLED BY: E. Altobellis (I18-07-9605)
SAMPLE TYPE: Grab
SAMPLE MATRIX: -

COMMENTS AND/OR INSTRUCTIONS:
T.A.T.: Need results by 10-12-2018
Date Collected: 10-5-2018
Stop First Positive
Point Count <4%

SAMPLE NUMBER	DATE & TIME	SAMPLE LOCATION	Description				
			Matrix	T/L	Color	Size & Comments	PLM
				W/C			
1 A, B	10/5/18	Bridge deck to abutment seam	Mastic/Tar	T/C	Black	~40' LF	X

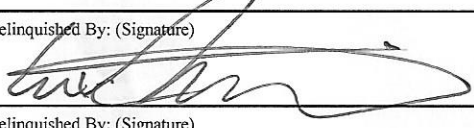
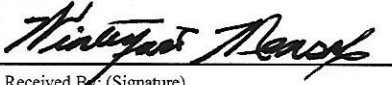
Relinquished By: (Signature) 	Date <u>10-5-18</u>	Time <u>1800</u>	Received By: (Signature) 
Relinquished By: (Signature)	Date	Time	Received By: (Signature)

Commonwealth of Kentucky
Department for Environmental Protection
Division for Air Quality



Eric Altobellis

Has met the requirements of 401 KAR 58:005 and is accredited as an:

**Asbestos
Inspector**

Accreditation Number: **118-07-9605**
Issue Date: **7/20/2018**
Expiration Date: **7/2/2019**

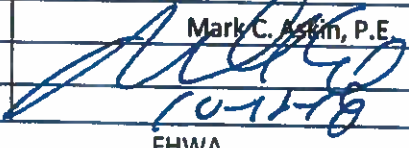
	KENTUCKY TRANSPORTATION CABINET Department of Highways DIVISION OF RIGHT OF WAY & UTILITIES	TC 62-226 Rev. 01/2016 Page 1 of 1
RIGHT OF WAY CERTIFICATION		

<input checked="" type="checkbox"/> Original		<input type="checkbox"/> Re-Certification		RIGHT OF WAY CERTIFICATION			
ITEM #		COUNTY		PROJECT # (STATE)		PROJECT # (FEDERAL)	
09-10005.00		Fleming		FD04 035 0111 007-008			
PROJECT DESCRIPTION							
ADDRESS DEFICIENCIES OF KY-111 BRIDGE OVER BR OF HILLSBORO CREEK. (035B00018N)							
<input checked="" type="checkbox"/> No Additional Right of Way Required							
Construction will be within the limits of the existing right of way. The right of way was acquired in accordance to FHWA regulations under the Uniform Relocation Assistance and Real Property Acquisitions Policy Act of 1970, as amended. No additional right of way or relocation assistance were required for this project.							
<input type="checkbox"/> Condition # 1 (Additional Right of Way Required and Cleared)							
All necessary right of way, including control of access rights when applicable, have been acquired including legal and physical possession. Trial or appeal of cases may be pending in court but legal possession has been obtained. There may be some improvements remaining on the right-of-way, but all occupants have vacated the lands and improvements, and KYTC has physical possession and the rights to remove, salvage, or demolish all improvements and enter on all land. Just Compensation has been paid or deposited with the court. All relocations have been relocated to decent, safe, and sanitary housing or that KYTC has made available to displaced persons adequate replacement housing in accordance with the provisions of the current FHWA directive.							
<input type="checkbox"/> Condition # 2 (Additional Right of Way Required with Exception)							
The right of way has not been fully acquired, the right to occupy and to use all rights-of-way required for the proper execution of the project has been acquired. Some parcels may be pending in court and on other parcels full legal possession has not been obtained, but right of entry has been obtained, the occupants of all lands and improvements have vacated, and KYTC has physical possession and right to remove, salvage, or demolish all improvements. Just Compensation has been paid or deposited with the court for most parcels. Just Compensation for all pending parcels will be paid or deposited with the court prior to AWARD of construction contract							
<input type="checkbox"/> Condition # 3 (Additional Right of Way Required with Exception)							
The acquisition or right of occupancy and use of a few remaining parcels are not complete and/or some parcels still have occupants. All remaining occupants have had replacement housing made available to them in accordance with 49 CFR 24.204. KYTC is hereby requesting authorization to advertise this project for bids and to proceed with bid letting even though the necessary right of way will not be fully acquired, and/or some occupants will not be relocated, and/or the just compensation will not be paid or deposited with the court for some parcels until after bid letting. KYTC will fully meet all the requirements outlined in 23 CFR 635.309(c)(3) and 49 CFR 24.102(j) and will expedite completion of all acquisitions, relocations, and full payments after bid letting and prior to AWARD of the construction contract or force account construction.							
Total Number of Parcels on Project		0		EXCEPTION (S) Parcel #		ANTICIPATED DATE OF POSSESSION WITH EXPLANATION	
Number of Parcels That Have Been Acquired							
Signed Deed		0					
Condemnation		0					
Signed ROE		0					
Notes/ Comments (Use Additional Sheet if necessary)							
LPA RW Project Manager				Right of Way Supervisor			
Printed Name		Chad Bourke, P.E.		Printed Name		Mark C. Aspin, P.E.	
Signature				Signature			
Date		10-12-18		Date		10-12-18	
Right of Way Director				FHWA			
Printed Name		Dean M. Loy		Printed Name			
Signature				Signature			
Date		12 OCT 2018		Date			

UTILITIES AND RAIL CERTIFICATION NOTE

Fleming County
KY 111 over Branch of Hillsboro Creek
SYP 09-10005

Utility coordination efforts conducted by the project sponsor have determined that no significant utility relocation work is required to complete the project. Any work pertaining to these utility facilities is defined in the bid package and is to be carried out as instructed by the Kentucky Transportation Cabinet. The contractor will be responsible for any coordination or adjustments that are discussed or quantified in the proposal.

THE FOLLOWING RAIL COMPANIES HAVE FACILITIES IN CONJUNCTION WITH THIS PROJECT AS NOTED

No Rail Involved **Minimal Rail Involved (See Below)** **Rail Involved (See Below)**

UNDERGROUND FACILITY DAMAGE PROTECTION – BEFORE YOU DIG

The contractor shall make every effort to protect underground facilities from damage as prescribed in the Underground Facility Damage Protection Act of 1994, Kentucky Revised Statute KRS 367.4901 to 367.4917. It is the contractor's responsibility to determine and take steps necessary to be in compliance with federal and state damage prevention directives. The contractor is instructed to contact KY 811 for the location of existing underground utilities. Contact shall be made a minimum of two (2) and no more than ten (10) business days prior to excavation.

The contractor shall submit Excavation Locate Requests to the Kentucky Contact Center (KY 811) via web ticket entry. The submission of this request does not relieve the contractor from the responsibility of contacting non-member facility owners, whom are to be contacted through their individual Protection Notification Center. It may be necessary for the contractor to contact the County Court Clerk to determine what utility companies have facilities in the area. Non-compliance with these directives can result in the enforcement of penalties.

SPECIAL CAUTION NOTE – PROTECTION OF UTILITIES

The contractor will be responsible for contacting all utility facility owners on the subject project to coordinate his activities. The contractor will coordinate his activities to minimize and, where possible, avoid conflicts with utility facilities. Due to the nature of the work proposed, it is unlikely to conflict with the existing utilities beyond minor facility adjustments. Where conflicts with utility facilities are unavoidable, the contractor will coordinate any necessary relocation work with the facility owner and Resident Engineer. The

Kentucky Transportation Cabinet maintains the right to remove or alter portions of this contract if a utility conflict occurs.

UTILITIES AND RAIL CERTIFICATION NOTE

Fleming County
KY 111 over Branch of Hillsboro Creek
SYP 09-10005

The utility facilities as noted in the previous section(s) have been determined using data garnered by varied means and with varying degrees of accuracy: from the facility owners, a result of S.U.E., field inspections, and/or reviews of record drawings. The facilities defined may not be inclusive of all utilities in the project scope and are not Level A quality, unless specified as such. It is the contractor's responsibility to verify all utilities and their respective locations before excavating.

Please Note: The information presented in this Utility Note is informational in nature and the information contained herein is not guaranteed.

AREA UTILITIES CONTACT LIST AS PROVIDED BY KY 811

<u>Utility Company/Agency</u>	<u>Contact Name</u>	<u>Contact Information</u>
<u>AT & T</u>	<u>Frank Ambrose</u>	<u>(502) 867-8240</u>
<u>Fleming Mason Energy</u>	<u>Brandon Hunt</u>	<u>(502) 828-3472</u>
<u>Fleming Co. Water</u>	<u>Kevin Cornette</u>	<u>(606) 845-3981</u>

Kentucky Transportation
Cabinet Project: 9-10005

NOTICE

**DEPARTMENT OF THE ARMY
CORPS OF ENGINEERS
NATIONWIDE SECTION 404 PERMIT AUTHORIZATION**

**DEPARTMENT FOR ENVIRONMENTAL PROTECTION
KENTUCKY DIVISION OF WATER
SECTION 401 WATER QUALITY CERTIFICATION**

**PROJECT DESCRIPTION: Replacement of KY 111 Bridge over Hillsboro Branch.
Fleming County, KY
KYTC Item No. 9-10005**

The Sections 404 and 401 activities for this project have previously been permitted under the authority of the Department of the Army, Nationwide Section 404 Permit Number 14, *Linear Transportation Projects* (with additional *Kentucky Regional General Conditions*), and the Division of Section 401 Water General Water Quality Certification. For these authorized permits to be valid, the attached conditions must be followed. The contractor shall post a copy of this Nationwide Number 14 permit and General Water Quality Certification in a conspicuous location at the project site, with unencumbered public access, for the duration of construction and comply with the general conditions required.

Locations Impacting Water Quality

Station-Location	Description
Bridge ID: 035B00018N	The project will involve replacement of the existing superstructure and repairing the abutments of the existing KY 111 bridge over Hillsboro Branch. The existing concrete deck, beams, and asphalt overlay will be removed and replaced with steel beams, a concrete deck, and steel railing. The abutments will receive patching, epoxy crack injection, and surface sealing. The contractor and/or equipment will need to work near the edge of the water to perform this work. Temporary work pads or crossings in the water are not anticipated. Project will not result in the loss of greater than 0.1 acre of waters of the U.S.; will not result in the loss of greater than 300 linear feet of ephemeral, intermittent, or perennial stream; and will not discharge to a special aquatic site.

Kentucky Transportation
Cabinet Project: 9-10005

This project involves work near and/or within Jurisdictional Waters of the United States as defined by the U. S. Army Corps of Engineers; therefore, requiring a Nationwide Number 14 General Section 404 permit. The Division of Water conditionally certified this General Permit. Importantly, one of those conditions regards the use of heavy equipment in any stream channel, or streambed. If there is need to cross the stream channel with heavy equipment, or conduct work within the stream channel, a work platform or temporary crossing, is authorized. This should be constructed with clean rock (preferably sandstone or granite east of a line stretching from the McCreary-Wayne County line to the southwest, northeasterly to Lewis-Greenup County line), and sufficient pipe to allow stream flow to continue, unimpeded (refer to the attached standard drawing for low-water crossings at end of the document). Other conditions may be found under the heading, *General Certification—Nationwide Permit # 14 Linear Transportation Projects*.

In order for this authorization to be valid, the attached conditions must be followed. The contractor shall post a copy of this Nationwide Number 14 Approval in a conspicuous location at the project site, for the duration of the construction, and comply with the general conditions as required.

To more readily expedite construction, the contractor may elect to alter the design, or perform the work in a manner different from what was originally proposed and specified. Prior to commencing such alternative work, the contractor shall obtain written permission from the Division of Construction and the Kentucky Transportation Cabinet, Division of Environmental Analysis. If such changes necessitate further permitting, then the contractor will be responsible for applying to the U. S. Army Corps of Engineers and the Kentucky Division of Water. A copy of any request to the Corps of Engineers or Division of Water to alter this proposal and subsequent responses shall be forwarded to the Division of Environmental Analysis, DA Permit Coordinator, for office records and for informational purposes.



MATTHEW G. BEVIN
GOVERNOR

CHARLES G. SNAVELY
SECRETARY

**ENERGY AND ENVIRONMENT CABINET
DEPARTMENT FOR ENVIRONMENTAL PROTECTION**

R. BRUCE SCOTT
COMMISSIONER

300 SOWER BOULEVARD
FRANKFORT, KENTUCKY 40601

**General Certification--Nationwide Permit # 14
Linear Transportation Projects**

This General Certification is issued March 19, 2017, in conformity with the requirements of Section 401 of the Clean Water Act of 1977, as amended (33 U.S.C. §1341), as well as Kentucky Statute KRS 224.16-050.

For this and all nationwide permits, the definition of surface water is as per 401 KAR 10:001 Chapter 10, Section 1(80): Surface Waters means those waters having well-defined banks and beds, either constantly or intermittently flowing; lakes and impounded waters; marshes and wetlands; and any subterranean waters flowing in well-defined channels and having a demonstrable hydrologic connection with the surface. Lagoons used for waste treatment and effluent ditches that are situated on property owned, leased, or under valid easement by a permitted discharger are not considered to be surface waters of the commonwealth.

Agricultural operations, as defined by KRS 224.71-100(1) conducting activities pursuant to KRS 224.71-100 (3), (4), (5), (6), or 10 are deemed to have certification if they are implementing an Agriculture Water Quality Plan pursuant to KRS 224.71-145.

For all other operations, the Commonwealth of Kentucky hereby certifies under Section 401 of the Clean Water Act (CWA) that it has reasonable assurances that applicable water quality standards under Kentucky Administrative Regulations Title 401, Chapter 10, established pursuant to Sections 301, 302, 304, 306 and 307 of the CWA, will not be violated for the activity covered under NATIONWIDE PERMIT 14, namely Linear Transportation Projects, provided that the following conditions are met:

1. The activity will not occur within surface waters of the Commonwealth identified by the Kentucky Division of Water as Outstanding State or National Resource Water, Cold Water Aquatic Habitat, or Exceptional Waters.
2. The activity will not occur within surface waters of the Commonwealth identified as perpetually-protected (e.g. deed restriction, conservation easement) mitigation sites.
3. The activity will impact less than 1/2 acre of wetland/marsh.

General Certification--Nationwide Permit # 14
Linear Transportation Projects
Page 2

4. The activity will impact less than 300 linear feet of surface waters of the Commonwealth. Stream realignment greater than 100 feet and in-stream stormwater detention/retention basins are not covered under this general water quality certification.
5. For complete linear transportation projects, all impacts shall not exceed a cumulative length of 500 linear feet within each Hydrologic Unit Code (HUC) 14.
6. Any crossings must be constructed in a manner that does not impede natural water flow.
7. Stream impacts covered under this General Water Quality Certification and undertaken by those persons defined as an agricultural operation under the Agricultural Water Quality Act must be completed in compliance with the Kentucky Agricultural Water Quality Plan (KWQP).
8. The Kentucky Division of Water may require submission of a formal application for an individual certification for any project if the project has been determined to likely have a significant adverse effect upon water quality or degrade the waters of the Commonwealth so that existing uses of the water body or downstream waters are precluded.
9. Activities that do not meet the conditions of this General Water Quality Certification require an Individual Section 401 Water Quality Certification.
10. Activities qualifying for coverage under this General Water Quality Certification are subject to the following conditions:
 - Projects requiring in-stream stormwater detention/retention basins shall require individual water quality certifications.
 - Erosion and sedimentation pollution control plans and Best Management Practices must be designed, installed, and maintained in effective operating condition at all times during construction activities so that violations of state water quality standards do not occur (401 KAR 10:031 Section 2 and KRS 224.70-100).
 - Sediment and erosion control measures, such as check-dams constructed of any material, silt fencing, hay bales, etc., shall not be placed within surface waters of the Commonwealth, either temporarily or permanently, without prior approval by the Kentucky Division of Water's Water Quality Certification Section. If placement of sediment and erosion control measures in surface waters is unavoidable, design and placement of temporary erosion control measures shall not be conducted in such a manner that may result in instability of streams that are adjacent to,

General Certification--Nationwide Permit # 14
Linear Transportation Projects
Page 3

upstream, or downstream of the structures. All sediment and erosion control devices shall be removed and the natural grade restored within the completion timeline of the activities.

- Measures shall be taken to prevent or control spills of fuels, lubricants, or other toxic materials used in construction from entering the watercourse.
- Removal of riparian vegetation in the utility line right-of-way shall be limited to that necessary for equipment access.
- To the maximum extent practicable, all in-stream work under this certification shall be performed under low-flow conditions.
- Heavy equipment, e.g. bulldozers, backhoes, draglines, etc., if required for this project, should not be used or operated within the stream channel. In those instances in which such in-stream work is unavoidable, then it shall be performed in such a manner and duration as to minimize turbidity and disturbance to substrates and bank or riparian vegetation.
- Any fill shall be of such composition that it will not adversely affect the biological, chemical, or physical properties of the receiving waters and/or cause violations of water quality standards. If rip-rap is utilized, it should be of such weight and size that bank stress or slump conditions will not be created because of its placement.
- If there are water supply intakes located downstream that may be affected by increased turbidity and suspended solids, the permittee shall notify the operator when such work will be done.
- Should evidence of stream pollution or jurisdictional wetland impairment and/or violations of water quality standards occur as a result of this activity (either from a spill or other forms of water pollution), the KDOW shall be notified immediately by calling (800) 928-2380.

Non-compliance with the conditions of this general certification or violation of Kentucky state water quality standards may result in civil penalties.



**US Army Corps
of Engineers®**
Louisville District

2017 Nationwide Permit General Conditions

The following General Conditions must be followed in order for any authorization by NWP to be valid:

1. Navigation. (a) No activity may cause more than a minimal adverse effect on navigation.

(b) Any safety lights and signals prescribed by the US Coast Guard, through regulations or otherwise, must be installed and maintained at the permittee's expense on authorized facilities in navigable waters of the United States.

(c) The permittee understands and agrees that, if future operations by the United States require the removal, relocation, or other alteration, of the structure or work herein authorized, or if, in the opinion of the Secretary of the Army or his authorized representative, said structure or work shall cause unreasonable obstruction to the free navigation of the navigable waters, the permittee will be required, upon due notice from the Corps of Engineers, to remove, relocate, or alter the structural work or obstructions caused thereby, without expense to the United States. No claim shall be made against the United States on account of any such removal or alteration.

2. Aquatic Life Movements. No activity may substantially disrupt the necessary life cycle movements of those species of aquatic life indigenous to the waterbody, including those species that normally migrate through the area, unless the activity's primary purpose is to impound water. All permanent and temporary crossings of waterbodies shall be suitably culverted, bridged, or otherwise designed and constructed to maintain low flows to sustain the movement of those aquatic species.

3. Spawning Areas. Activities in spawning areas during spawning seasons must be avoided to the maximum extent practicable. Activities that result in the physical destruction (e.g., through excavation, fill, or downstream smothering by substantial turbidity) of an important spawning area are not authorized.

4. Migratory Bird Breeding Areas. Activities in waters of the United States that serve as breeding areas for migratory birds must be avoided to the maximum extent practicable.

5. Shellfish Beds. No activity may occur in areas of concentrated shellfish populations, unless the activity is directly related to a shellfish harvesting activity authorized by NWPs 4 and 48, or is a shellfish seeding or habitat restoration activity authorized by NWP 27.

6. Suitable Material. No activity may use unsuitable material (e.g., trash, debris, car bodies, asphalt, etc.). Material used for construction or discharged must be free from toxic pollutants in toxic amounts (see Section 307 of the Clean Water Act).

7. Water Supply Intakes. No activity may occur in the proximity of a public water supply intake, except where the activity is for the repair or improvement of public water supply intake structures or adjacent bank stabilization.

8. Adverse Effects From Impoundments. If the activity creates an impoundment of water, adverse effects to the aquatic system due to accelerating the passage of water, and/or restricting its flow must be minimized to the maximum extent practicable.

9. Management of Water Flows. To the maximum extent practicable, the pre-construction course, condition, capacity, and location of open waters must be maintained for each activity, including stream channelization, storm water management activities, and temporary and permanent road crossings, except as provided below. The activity must be constructed to withstand expected high flows. The activity must not restrict or impede the passage of normal or high flows, unless the primary purpose of the activity is to impound water or manage high flows. The activity may alter the pre-construction course, condition, capacity, and location of open waters if it benefits the aquatic environment (e.g., stream restoration or relocation activities).

10. Fills Within 100-Year Floodplains. The activity must comply with applicable FEMA-approved state or local floodplain management requirements.

11. Equipment. Heavy equipment working in wetlands or mudflats must be placed on mats, or other measures must be taken to minimize soil disturbance.

12. Soil Erosion and Sediment Controls. Appropriate soil erosion and sediment controls must be used and maintained in effective operating condition during construction, and all exposed soil and other fills, as well as any work below the ordinary high water mark or high tide line, must be permanently stabilized at the earliest practicable date. Permittees are encouraged to perform work within waters of the United States during periods of low-flow or no-flow, or during low tides.

13. Removal of Temporary Fills. Temporary fills must be removed in their entirety and the affected areas returned to pre-construction elevations. The affected areas must be revegetated, as appropriate.

14. Proper Maintenance. Any authorized structure or fill shall be properly maintained, including maintenance to ensure public safety and compliance with applicable NWP general conditions, as well as any activity-specific conditions added by the district engineer to an NWP authorization.

15. Single and Complete Project. The activity must be a single and complete project. The same NWP cannot be used more than once for the same single and complete project.

16. Wild and Scenic Rivers. (a) No activity may occur in a component of the National Wild and Scenic River System, or in a river officially designated by Congress as a "study river" for possible inclusion in the system while the river is in an official study status, unless the appropriate Federal agency with direct management responsibility for such river, has determined in writing that the proposed activity will not adversely affect the Wild and Scenic River designation or study status.

(b) If a proposed NWP activity will occur in a component of the National Wild and Scenic River System, or in a river officially designated by Congress as a "study river" for possible inclusion in the system while the river is in an official study status, the permittee must submit a pre-construction notification (see general condition 32). The district engineer will coordinate the PCN with the Federal agency with direct management responsibility for that river. The permittee shall not begin the NWP activity until notified by the district engineer that the Federal agency with direct management responsibility for that river has determined in writing that the proposed NWP activity will not adversely affect the Wild and Scenic River designation or study status.

(c) Information on Wild and Scenic Rivers may be obtained from the appropriate Federal land management agency responsible for the designated Wild and Scenic River or study river (e.g., National Park Service, U.S. Forest Service, Bureau of Land Management, U.S. Fish and Wildlife Service). Information on these rivers is also available at: <http://www.rivers.gov/>

17. Tribal Rights. No activity may impair tribal rights (including treaty rights), protected tribal resources, or tribal lands.

18. Endangered Species. (a) No activity is authorized under any NWP which is likely to directly or indirectly jeopardize the continued existence of a threatened or endangered species or a species proposed for such designation, as identified under the Federal Endangered Species Act (ESA), or which will directly or indirectly destroy or adversely modify the critical habitat of such species. No activity is authorized under any NWP which "may affect" a listed species or critical habitat, unless section 7 consultation addressing the effects of the proposed activity has been completed. Direct effects are the immediate effects on the listed species and critical habitat caused by the NWP activity. Indirect effects are those effects on listed species and critical habitat that are caused by the NWP activity and are later in time, but still are reasonably certain to occur.

(b) Federal agencies should follow their own procedures for complying with the requirements of the ESA. If pre-construction notification is required for the proposed activity, the Federal permittee must provide the district engineer with the appropriate documentation to demonstrate compliance with those requirements. The district engineer will verify that the appropriate documentation has been submitted. If the appropriate documentation has not been submitted, additional ESA section 7 consultation may be necessary for the activity and the respective federal agency would be responsible for fulfilling its obligation under section 7 of the ESA.

(c) Non-federal permittees must submit a pre-construction notification (PCN) to the district engineer if any listed species or designated critical habitat might be affected or is in the vicinity of the activity, or if the activity is located in designated critical habitat, and shall not begin work on the activity until notified by the district engineer that the requirements of the ESA have been satisfied and that the activity is authorized. For activities that might affect Federally-listed endangered or threatened species or designated critical habitat, the PCN must include the name(s) of the endangered or threatened species that might be affected by the proposed activity or that utilize the designated critical habitat that might be affected by the proposed work. The district engineer will determine whether the proposed activity "may affect" or will have "no effect" to listed species and designated critical habitat and will notify the non-Federal applicant of the Corps' determination within 45 days of receipt of a complete PCN. In cases where the non-Federal applicant has identified listed species or critical habitat that might be affected or is in the vicinity of the activity, and has so notified the Corps, the applicant shall not begin work until the Corps has provided notification the proposed activities will have "no effect" on listed species or critical habitat, or until Section 7 consultation has been completed. If the non-Federal applicant has not heard back from the Corps within 45 days, the applicant must still wait for notification from Corps.

(d) As a result of formal or informal consultation with the USFWS or NMFS the district engineer may add species-specific permit conditions to the NWP.

(e) Authorization of an activity by a NWP does not authorize the "take" of a threatened or endangered species as defined under the ESA. In the absence of separate authorization (e.g., an ESA Section 10 Permit, a Biological Opinion with "incidental take" provisions, etc.) from the USFWS or the NMFS, the Endangered Species Act prohibits any person subject to the jurisdiction of the United States to take a listed species, where "take" means to harass, harm, pursue, hunt, shoot, wound, kill, trap, capture, or collect, or to attempt to engage in any such conduct. The word "harm" in the definition of "take" means an act which actually kills or injures wildlife. Such an act may include significant habitat modification or degradation where it actually kills or injures wildlife by significantly impairing essential behavioral patterns, including breeding, feeding or sheltering.

(f) If the non-federal permittee has a valid ESA section 10(a)(1)(B) incidental take permit with an approved Habitat Conservation Plan for a project or a group of projects that includes the proposed NWP activity, the non-federal applicant should provide a copy of that ESA section 10(a)(1)(B) permit with the PCN required by paragraph (c) of this general condition. The district engineer will review the ESA section 10(a)(1)(B) permit, and if he or she determines that it covers the proposed NWP activity, including any incidental take of listed species that might occur as a result of conducting the proposed NWP activity, the district engineer does not need to conduct a separate section 7 consultation for the proposed NWP activity. The district engineer will notify the non-federal applicant within 45 days of receipt of a complete PCN whether the ESA section 10(a)(1)(B) permit covers the proposed NWP activity or whether additional ESA section 7 consultation is required.

(g) Information on the location of threatened and endangered species and their critical habitat can be obtained directly from the offices of the USFWS and NMFS or their world wide web pages at <http://www.fws.gov/> or <http://www.fws.gov/ipac> and <http://www.nmfs.noaa.gov/pr/species/esa> respectively.

19. Migratory Birds and Bald and Golden Eagles. The permittee is responsible for ensuring their action complies with the Migratory Bird Treaty Act and the Bald and Golden Eagle Protection Act. The permittee is responsible for contacting appropriate local office of the U.S. Fish and Wildlife Service to determine applicable measures to reduce impacts to migratory birds or eagles, including whether "incidental take" permits are necessary and available under the Migratory Bird Treaty Act or Bald and Golden Eagle Protection Act for a particular activity.

20. Historic Properties. (a) In cases where the district engineer determines that the activity may have the potential to cause effects to properties listed, or eligible for listing, in the National Register of Historic Places, the activity is not authorized, until the requirements of Section 106 of the National Historic Preservation Act (NHPA) have been satisfied.

(b) Federal permittees should follow their own procedures for complying with the requirements of Section 106 of the National Historic Preservation Act. If pre-construction notification is required for the proposed NWP activity, the Federal permittee must provide the district engineer with the appropriate documentation to demonstrate compliance with those

requirements. The district engineer will verify that the appropriate documentation has been submitted. If the appropriate documentation is not submitted, then additional consultation under section 106 may be necessary. The respective federal agency is responsible for fulfilling its obligation to comply with section 106.

(c) Non-federal permittees must submit a pre-construction notification to the district engineer if the NWP activity might have the potential to cause effects to any historic properties listed on, determined to be eligible for listing on, or potentially eligible for listing on the National Register of Historic Places, including previously unidentified properties. For such activities, the pre-construction notification must state which historic properties might have the potential to be affected by the proposed activity or include a vicinity map indicating the location of the historic properties or the potential for the presence of historic properties. Assistance regarding information on the location of or potential for the presence of historic properties can be sought from the State Historic Preservation Officer, Tribal Historic Preservation Officer, or designated tribal representative, as appropriate, and the National Register of Historic Places (see 33 CFR 330.4(g)). When reviewing pre-construction notifications, district engineers will comply with the current procedures for addressing the requirements of Section 106 of the National Historic Preservation Act. The district engineer shall make a reasonable and good faith effort to carry out appropriate identification efforts, which may include background research, consultation, oral history interviews, sample field investigation, and field survey. Based on the information submitted in the PCN and these identification efforts, the district engineer shall determine whether the proposed NWP activity has the potential to cause an effect on the historic properties. Section 106 consultation is not required when the district engineer determines that the activity does not have the potential to cause effects on historic properties (see 36 CFR 800.3(a)). Section 106 consultation is required when the district engineer determines that the activity has the potential to cause effects on historic properties. The district engineer will conduct consultation with consulting parties identified under 36 CFR 800.2(c) when he or she makes any of the following effect determinations for the purposes of section 106 of the NHPA: no historic properties affected, no adverse effect, and adverse effect. Where the non-Federal applicant has identified historic properties on which the activity might have the potential to cause effects and notified the Corps, the non-Federal applicant shall not begin the activity until notified by the district engineer either that the activity has no potential to cause effects to historic properties or that NHPA section 106 consultation has been completed.

(d) For non-federal permittees, the district engineer will notify the prospective permittee within 45 days of receipt of a complete pre-construction notification whether NHPA section 106 consultation is required. If NHPA section 106 consultation is required, the district engineer will notify the non-Federal applicant that he or she cannot begin the activity until Section 106 consultation is completed. If the non-Federal applicant has not heard back from the Corps within 45 days, the applicant must still wait for notification from the Corps.

(e) Prospective permittees should be aware that section 110k of the NHPA (54 U.S.C. 306113) prevents the Corps from granting a permit or other assistance to an applicant who, with intent to avoid the requirements of Section 106 of the NHPA, has intentionally significantly adversely affected a historic property to which the permit would relate, or having legal power to prevent it, allowed such significant adverse effect to occur, unless the Corps, after consultation with the Advisory Council on Historic Preservation (ACHP), determines that circumstances justify granting such assistance despite the adverse effect created or permitted by the applicant. If circumstances justify granting the assistance, the Corps is required to notify the ACHP and provide documentation specifying the circumstances, the degree of damage to the integrity of any historic properties affected, and proposed mitigation. This documentation must include any views obtained from the applicant, SHPO/THPO, appropriate Indian tribes if the undertaking occurs on or affects historic properties on tribal lands or affects properties of interest to those tribes, and other parties known to have a legitimate interest in the impacts to the activity on historic properties.

21. Discovery of Previously Unknown Remains and Artifacts. If you discover any previously unknown historic, cultural or archeological remains and artifacts while accomplishing the activity authorized by this permit, you must immediately notify the district engineer of what you have found, and to the maximum extent practicable, avoid construction activities that may affect the remains and artifacts until the required coordination has been completed. The district engineer will initiate the Federal, Tribal and state coordination required to determine if the items or remains warrant recovery effort or if the site is eligible for listing in the National Register of Historic Places.

22. Designated Critical Resource Waters. Critical resource waters include, NOAA-managed marine sanctuaries and marine monuments, and National Estuarine Research Reserves. The district engineer may designate, after notice and opportunity for public comment, additional waters officially designated by a state as having particular environmental or ecological significance, such as outstanding national resource waters or state natural heritage sites. The district engineer may also designate additional critical resource waters after notice and opportunity for public comment.

(a) Discharges of dredged or fill material into waters of the US are not authorized by NWP's 7, 12, 14, 16, 17, 21, 29, 31, 35, 39, 40, 42, 43, 44, 49, 50, 51, and 52 for any activity within, or directly affecting, critical resource waters, including wetlands adjacent to such waters.

(b) For NWP's 3, 8, 10, 13, 15, 18, 19, 22, 23, 25, 27, 28, 30, 33, 34, 36, 37, 38, and 54, notification is required in accordance with general condition 32, for any activity proposed in the designated critical resource waters including wetlands adjacent to those waters. The district engineer may authorize activities under these NWP's only after it is determined that the impacts to the critical resource waters will be no more than minimal.

23. Mitigation. The district engineer will consider the following factors when determining appropriate and practicable mitigation necessary to ensure that the individual and cumulative adverse environmental effects are no more than minimal:

(a) The activity must be designed and constructed to avoid and minimize adverse effects, both temporary and permanent, to waters of the United States to the maximum extent practicable at the project site (i.e., on site).

(b) Mitigation in all its forms (avoiding, minimizing, rectifying, reducing, or compensating for resource losses) will be required to the extent necessary to ensure that the individual and cumulative adverse environmental effects are no more than minimal.

(c) Compensatory mitigation at a minimum one-for-one ratio will be required for all wetland losses that exceed 1/10-acre and require pre-construction notification, unless the district engineer determines in writing that either some other form of mitigation would be more environmentally appropriate or the adverse effects of the proposed activity are minimal, and provides a project-specific waiver of this requirement. For wetland losses of 1/10-acre or less that require pre-construction notification, the district engineer may determine on a case-by-case basis that compensatory mitigation is required to ensure that the activity results in minimal adverse environmental effects.

(d) For losses of streams or other open waters that require pre-construction notification, the district engineer may require compensatory mitigation to ensure that the activity results in no more than minimal adverse environmental effects. Compensatory mitigation for losses of streams should be provided, if practicable, through stream rehabilitation, enhancement, or preservation, since streams are difficult-to-replace resources (see 33 CFR 332.3(e)(3)).

(e) Compensatory mitigation plans for NWP activities in or near streams or other open waters will normally include a requirement for the restoration or enhancement, maintenance, and legal protection (e.g. conservation easements) of riparian areas next to open waters. In some cases, the restoration or maintenance/protection of riparian areas may be the only compensatory mitigation required. Restored riparian areas should consist of native species. The width of the required riparian area will address documented water quality or aquatic habitat loss concerns. Normally, the riparian area will be 25 to 50 feet wide on each side of the stream, but the district engineer may require slightly wider riparian areas to address documented water quality or habitat loss concerns. If it is not possible to restore or maintain/protect a riparian area on the both sides of a stream or if the waterbody is a lake or coastal waters. Then restoring or maintaining/protecting a riparian area along a single bank or shoreline may be sufficient. Where both wetlands and open waters exist on the project site, the district engineer will determine the appropriate compensatory mitigation (e.g. riparian areas and/or wetlands compensation) based on what is best for the aquatic environmental on a watershed basis. In cases where riparian areas are determined to be the most appropriate form of minimization or compensatory mitigation, the district engineer may waive or reduce the requirement to provide wetland compensatory mitigation for wetland losses.

(f) Compensatory mitigation projects provided to offset losses of aquatic resources must comply with the applicable provisions of 33 CFR part 332.

(1) The prospective permittee is responsible for proposing an appropriate compensatory mitigation option if compensatory mitigation is necessary to ensure that the activity results in no more than minimal adverse environmental effects. For the NWP's, the preferred mechanism for providing compensatory mitigation is mitigation bank credits or in-lieu fee program credits (see 33 CFR 332.3(b)(2) and (3)). However, if an appropriate number and type of mitigation bank or in-lieu credits are not available at the time the PCN is submitted to the district engineer, the district engineer may approve the use of permittee-responsible mitigation if the use of mitigation bank or in-lieu fee program credits is not appropriate and practicable.

(2) The amount of compensatory mitigation required by the district engineer must be sufficient to ensure that the authorized activity results in no more than minimal individual and cumulative adverse environmental effects (see 33 CFR 330.1(e)(3)). (See also 33 CFR 332.3(f).)

(3) Since the likelihood of success is greater and the impacts to potentially valuable uplands are reduced, aquatic resource restoration should be the first compensatory mitigation option considered for permittee-responsible mitigation.

(4) If permittee-responsible mitigation is the proposed option, the prospective permittee is responsible for submitting a mitigation plan. A conceptual or detailed mitigation plan may be used by the district engineer to make the decision on the NWP verification request, but a final mitigation plan that addresses the applicable requirements of 33 CFR 332.4(c)(2) through (14) must be approved by the district engineer before the permittee begins work in waters of the United States, unless the district engineer determines that prior approval of the final mitigation plan is not practicable or not necessary to ensure timely completion of the required compensatory mitigation (see 33 CFR 332.3(k)(3)).

(5) If mitigation bank or in-lieu fee program credits are the proposed option, the mitigation plan only needs to address the baseline conditions at the impact site and the number of credits to be provided.

(6) Compensatory mitigation requirements (e.g., resource type and amount to be provided as compensatory mitigation, site protection, ecological performance standards, monitoring requirements) may be addressed through conditions added to the NWP authorization, instead of components of a compensatory mitigation plan.

(g) Compensatory mitigation will not be used to increase the acreage losses allowed by the acreage limits of the NWP's. For example, if an NWP has an acreage limit of 1/2-acre, it cannot be used to authorize any project resulting in the loss of greater than 1/2-acre of waters of the United States, even if compensatory mitigation is provided that replaces or restores some of the lost waters. However, compensatory mitigation can and should be used, as necessary, to ensure that an NWP activity already meeting the established acreage limits also satisfies the minimal impact requirement for the NWP's.

(h) Permittees may propose the use of mitigation banks, in-lieu fee programs, or separate permittee-responsible mitigation. When developing a compensatory mitigation proposal, the permittee must consider appropriate and practicable options consistent with the framework at 33 CFR 332.3(b). For activities resulting in the loss of marine or estuarine resources, permittee-responsible compensatory mitigation may be environmentally preferable if there are no mitigation banks or in-lieu fee programs in the area that have marine or estuarine credits available for sale or transfer to the permittee. For permittee-responsible mitigation, the special conditions of the NWP verification must clearly indicate the party or parties responsible for the implementation and performance of the compensatory mitigation project, and, if required, its long-term management.

(i) Where certain functions and services of waters of the United States are permanently adversely affected by a regulated activity, such as discharges of dredged or fill material into waters of the United States that will convert a forested or scrub-shrub wetland to a herbaceous wetland in a permanently maintained utility line right-of-way, mitigation may be required to reduce the adverse environmental effects of the activity to the no more than minimal level.

24. Safety of Impoundment Structures. To ensure that all impoundment structures are safely designed, the district engineer may require non-Federal applicants to demonstrate that the structures comply with established state dam safety criteria or have been designed by qualified persons. The district engineer may also require documentation that the design has been independently reviewed by similarly qualified persons, and appropriate modifications made to ensure safety.

25. Water Quality. Where States and authorized Tribes, or EPA where applicable, have not previously certified compliance of an NWP with CWA Section 401, individual 401 Water Quality

Certification must be obtained or waived (see 33 CFR 330.4(c)). The district engineer or State or Tribe may require additional water quality management measures to ensure that the authorized activity does not result in more than minimal degradation of water quality.

26. Coastal Zone Management. In coastal states where an NWP has not previously received a state coastal zone management consistency concurrence, an individual state coastal zone management consistency concurrence must be obtained, or a presumption of concurrence must occur (see 33 CFR 330.4(d)). The district engineer or a State may require additional measures to ensure that the authorized activity is consistent with state coastal zone management requirements.

27. Regional and Case-By-Case Conditions. The activity must comply with any regional conditions that may have been added by the Division Engineer (see 33 CFR 330.4(e)) and with any case specific conditions added by the Corps or by the state, Indian Tribe, or USEPA in its section 401 Water Quality Certification, or by the state in its Coastal Zone Management Act consistency determination.

28. Use of Multiple Nationwide Permits. The use of more than one NWP for a single and complete project is prohibited, except when the acreage loss of waters of the United States authorized by the NWPs does not exceed the acreage limit of the NWP with the highest specified acreage limit. For example, if a road crossing over tidal waters is constructed under NWP 14, with associated bank stabilization authorized by NWP 13, the maximum acreage loss of waters of the United States for the total project cannot exceed 1/3-acre.

29. Transfer of Nationwide Permit Verifications. If the permittee sells the property associated with a nationwide permit verification, the permittee may transfer the nationwide permit verification to the new owner by submitting a letter to the appropriate Corps district office to validate the transfer. A copy of the nationwide permit verification must be attached to the letter, and the letter must contain the following statement and signature: "When the structures or work authorized by this nationwide permit are still in existence at the time the property is transferred, the terms and conditions of this nationwide permit, including any special conditions, will continue to be binding on the new owner(s) of the property. To validate the transfer of this nationwide permit and the associated liabilities associated with compliance with its terms and conditions, have the transferee sign and date below."

(Transferee)

(Date)

30. Compliance Certification. Each permittee who receives an NWP verification letter from the Corps must provide a signed certification documenting completion of the authorized activity and implementation of any required compensatory mitigation. The success of any required permittee-responsible mitigation, including the achievement of ecological performance standards, will be addressed separately by the district engineer. The Corps will provide the permittee the certification document with the NWP verification letter. The certification document will include:

(a) A statement that the authorized work was done in accordance with the NWP authorization, including any general, regional, or activity-specific conditions;

(b) A statement that the implementation of any required compensatory mitigation was completed in accordance with the permit conditions. If credits from a mitigation bank or in-lieu fee program are used to satisfy the compensatory mitigation requirements, the certification must include the documentation required by 33 CFR 332.3(l)(3) to confirm that the permittee secured the appropriate number and resource type of credits; and

(c) The signature of the permittee certifying the completion of the work and mitigation. The completed certification document must be submitted to the district engineer within 30 days of completion of the authorized activity or the implementation of any required compensatory mitigation, whichever occurs later.

31. Activities Affecting Structures or Works Built by the United States. If an NWP activity also requires permission from the Corps pursuant to 33 U.S.C. 408 because it will alter or temporarily or permanently occupy or use a U.S. Army Corps of Engineers (USACE) federally

authorized Civil Works project (a "USACE project"), the prospective permittee must submit a pre-construction notification. See paragraph (b)(10) of general condition 32. An activity that requires Section 408 permission is not authorized by the NWP until the appropriate Corps office issues the section 408 permission to alter, occupy, or use the USACE project, and the district engineer issues a written NWP verification.

32. Pre-Construction Notification (PCN). (a) Timing. Where required by the terms of the NWP, the prospective permittee must notify the district engineer by submitting a pre-construction notification (PCN) as early as possible. The district engineer must determine if the PCN is complete within 30 calendar days of the date of receipt and, if the PCN is determined to be incomplete, notify the prospective permittee within that 30 day period to request the additional information necessary to make the PCN complete. As a general rule, district engineers will request additional information necessary to make the PCN complete only once. However, if the prospective permittee does not provide all of the requested information, then the district engineer will notify the prospective permittee that the PCN is still incomplete and the PCN review process will not commence until all of the requested information has been received by the district engineer. The prospective permittee shall not begin the activity until either:

(1) He or she is notified in writing by the district engineer that the activity may proceed under the NWP with any special conditions imposed by the district or division engineer; or

(2) 45 calendar days have passed from the district engineer's receipt of the complete PCN and the prospective permittee has not received written notice from the district or division engineer. However, if the permittee was required to notify the Corps pursuant to general condition 18 that listed species or critical habitat might be affected or in the vicinity of the project, or to notify the Corps pursuant to general condition 20 that the activity might have the potential to cause effects to historic properties, the permittee cannot begin the activity until receiving written notification from the Corps that there is "no effect" on listed species or "no potential to cause effects" on historic properties, or that any consultation required under Section 7 of the Endangered Species Act (see 33 CFR 330.4(f)) and/or Section 106 of the National Historic Preservation (see 33 CFR 330.4(g)) has been completed. Also, work cannot begin under NWPs 21, 49, or 50 until the permittee has received written approval from the Corps. If the proposed activity requires a written waiver to exceed specified limits of an NWP, the permittee may not begin the activity until the district engineer issues the waiver. If the district or division engineer notifies the permittee in writing that an individual permit is required within 45 calendar days of receipt of a complete PCN, the permittee cannot begin the activity until an individual permit has been obtained. Subsequently, the permittee's right to proceed under the NWP may be modified, suspended, or revoked only in accordance with the procedure set forth in 33 CFR 330.5(d)(2).

(b) Contents of Pre-Construction Notification: The PCN must be in writing and include the following information:

(1) Name, address and telephone numbers of the prospective permittee;

(2) Location of the proposed activity;

(3) Identify the specific NWP or NWP(s) the prospective permittee wants to use to authorize the proposed activity;

(4) A description of the proposed activity; the activity's purpose; direct and indirect adverse environmental effects the activity would cause, including the anticipated amount of loss of wetlands, other special aquatic sites, and other waters expected to result from the NWP activity, in acres, linear feet, or other appropriate unit of measure; a description of any proposed mitigation measures intended to reduce the adverse environmental effects caused by the proposed activity; and any other NWP(s), regional general permit(s), or individual permit(s) used or intended to be used to authorize any part of the proposed project or any related activity, including other separate and distant crossings for linear projects that require Department of the Army authorization but do not require pre-construction notification. The description of the proposed activity and any proposed mitigation measures should be sufficiently detailed to allow the district engineer to determine that the adverse environmental effects of the activity will be no more than minimal and to determine the need for compensatory mitigation or other mitigation measures. For single and complete linear projects, the PCN must include the quantity of anticipated losses of wetlands, other special aquatic sites, and other water for each single and complete crossing of those wetlands, other special aquatic sites, and other waters. Sketches should be provided when necessary to show that the activity complies with the terms of the NWP. (Sketches usually clarify the project and when provided results in a quicker decision. Sketches should contain sufficient detail to provide an

illustrative description of the proposed activity (e.g., a conceptual plan), but do not need to be detailed engineering plans);

(5) The PCN must include a delineation of wetlands, other special aquatic sites, and other waters, such as lakes and ponds, and perennial, intermittent, and ephemeral streams, on the project site. Wetland delineations must be prepared in accordance with the current method required by the Corps. The permittee may ask the Corps to delineate the special aquatic sites and other waters on the project site, but there may be a delay if the Corps does the delineation, especially if the project site is large or contains many wetlands, other special aquatic sites, and other waters. Furthermore, the 45 day period will not start until the delineation has been submitted to or completed by the Corps, as appropriate;

(6) If the proposed activity will result in the loss of greater than 1/10-acre of wetlands and a PCN is required, the prospective permittee must submit a statement describing how the mitigation requirement will be satisfied, or explaining why the adverse environmental effects are no more than minimal and why compensatory mitigation should not be required. As an alternative, the prospective permittee may submit a conceptual or detailed mitigation plan.

(7) For non-federal permittees, if any listed species or designated critical habitat might be affected or is in the vicinity of the project, or if the project is located in designated critical habitat, for non-Federal applicants the PCN must include the name(s) of those endangered or threatened species that might be affected by the proposed activity or utilize the designated critical habitat that may be affected by the proposed activity. For any NWP activity that requires pre-construction notification, Federal permittees must provide documentation demonstrating compliance with the Endangered Species Act;

(8) For non-federal permittees, if the NWP activity might have the potential to cause effects to a historic property listed on, determined to be eligible for listing on, or potentially eligible for listing on, the National Register of Historic Places, the PCN must state which historic property might have the potential to be affected by the proposed activity or include a vicinity map indicating the location of the historic property. Federal permittees must provide documentation demonstrating compliance with Section 106 of the National Historic Preservation Act.

(9) For an activity that will occur in a component of the National Wild and Scenic River System, or in a river officially designated by Congress as a "study river" for possible inclusion in the system while the river is in an official study status, the PCN must identify the Wild and Scenic River or the "study river" (see general condition 16); and

(10) For an activity that requires permission from the Corps pursuant to 33 U.S.C. 408 because it will alter or temporarily or permanently occupy or use a U.S. Army Corps of Engineers federally authorized civil works project, the pre-construction notification must include a statement confirming that the project proponent has submitted a written request for section 408 permission from the Corps office having jurisdiction over that USACE project.

(c) Form of PCN Notification: The standard individual permit application form (Form ENG 4345) may be used, but the completed application form must clearly indicate that it is an NWP PCN and must include all of the information required in paragraphs (b)(1) through (10) of this general condition. A letter containing the required information may also be used. Applicants may provide electronic files of PCNs and supporting materials if the district engineer has established tools and procedures for electronic submittals.

(d) Agency Coordination: (1) The district engineer will consider any comments from Federal and state agencies concerning the proposed activity's compliance with the terms and conditions of the NWPs and the need for mitigation to reduce the project's adverse environmental effects so that they are no more than minimal.

(2) Agency coordination is required for: (i) all NWP activities that require preconstruction notification and result in the loss of greater than 1/2-acre of waters of the United States; (ii) NWP 21, 29, 39, 40, 42, 43, 44, 50, 51, and 52 activities that require pre-construction notification and will result in the loss of greater than 300 linear feet of stream bed; (iii) NWP 13 activities in excess of 500 linear feet, fills greater than one cubic yard per running foot, or involve discharges of dredged or fill material into special aquatic sites; and (iv) NWP 54 activities in excess of 500 linear feet, or that extend into the waterbody more than 30 feet from the mean low water line or ordinary high water mark.

(3) When agency coordination is required, the district engineer will immediately provide (e.g., via e-mail, facsimile transmission, overnight mail, or other expeditious manner) a copy of the complete PCN to the appropriate Federal or state offices (FWS, state natural

resource or water quality agency, EPA, and, if appropriate, the NMFS). With the exception of NWP 37, these agencies will have 10 calendar days from the date the material is transmitted to notify the district engineer via telephone, facsimile transmission, or e-mail that they intend to provide substantive, sites specific comments. The comments must explain why the agency believes the adverse environmental effects will be more than minimal. If so contacted by an agency, the district engineer will wait an additional 15 calendar days before making a decision on the pre-construction notification. The district engineer will fully consider agency comments received within the specified time frame concerning the proposed activity's compliance with the terms and conditions of the NWPs, including the need for mitigation to ensure the net adverse environmental effects of the proposed activity are no more than minimal. The district engineer will provide no response to the resource agency, except as provided below. The district engineer will indicate in the administrative record associated with each pre-construction notification that the resource agencies' concerns were considered. For NWP 37, the emergency watershed protection and rehabilitation activity may proceed immediately in cases where there is an unacceptable hazard to life or a significant loss of property or economic hardship will occur. The district engineer will consider any comments received to decide whether the NWP 37 authorization should be modified, suspended, or revoked in accordance with the procedures at 33 CFR 330.5.

(4) In cases of where the prospective permittee is not a Federal agency, the district engineer will provide a response to NMFS within 30 calendar days of receipt of any Essential Fish Habitat conservation recommendations, as required by Section 305(b)(4)(B) of the Magnuson-Stevens Fishery Conservation and Management Act.

(5) Applicants are encouraged to provide the Corps with either electronic files or multiple copies of PCN notifications to expedite agency coordination.

Further Information

1. District Engineers have authority to determine if an activity complies with the terms and conditions of an NWP.

2. NWPs do not obviate the need to obtain other federal, state, or local permits, approvals, or authorizations required by law.

3. NWPs do not grant any property rights or exclusive privileges.

4. NWPs do not authorize any injury to the property or rights of others.

5. NWPs do not authorize interference with any existing or proposed Federal project (see general condition 31).

Terms for Nationwide Permit No. 14 – Linear Transportation Projects

Activities required for crossings of waters of the United States associated with the construction, expansion, modification, or improvement of linear transportation projects (e.g., roads, highways, railways, trails, airport runways, and taxiways) in waters of the United States. For linear transportation projects in non-tidal waters, the discharge cannot cause the loss of greater than 1/2-acre of waters of the United States. For linear transportation projects in tidal waters, the discharge cannot cause the loss of greater than 1/3-acre of waters of the United States. Any stream channel modification, including bank stabilization, is limited to the minimum necessary to construct or protect the linear transportation project; such modifications must be in the immediate vicinity of the project.

This NWP also authorizes temporary structures, fills, and work, including the use of temporary mats, necessary to construct the linear transportation project. Appropriate measures must be taken to maintain normal downstream flows and minimize flooding to the maximum extent practicable, when temporary structures, work, and discharges, including cofferdams, are necessary for construction activities, access fills, or dewatering of construction sites. Temporary fills must consist of materials, and be placed in a manner, that will not be eroded by expected high flows. Temporary fills must be removed in their entirety and the affected areas returned to pre-construction elevations. The areas affected by temporary fills must be revegetated, as appropriate.

This NWP cannot be used to authorize non-linear features commonly associated with transportation projects, such as vehicle maintenance or storage buildings, parking lots, train stations, or aircraft hangars.

Notification: The permittee must submit a pre-construction notification to the district engineer prior to commencing the activity if: (1) the loss of waters of the United States exceeds 1/10-acre; or (2) there is a discharge in a special aquatic site, including wetlands. (See general condition 32.) (Authorities: Sections 10 and 404)

Note 1: For linear transportation projects crossing a single waterbody more than one time at separate and distant locations, or multiple waterbodies at separate and distant locations, each crossing is considered a single and complete project for purposes of NWP authorization. Linear transportation projects must comply with 33 CFR 330.6(d).

Note 2: Some discharges for the construction of farm roads or forest roads, or temporary roads for moving mining equipment, may qualify for an exemption under section 404(f) of the Clean Water Act (see 33 CFR 323.4).

Note 3: For NWP 14 activities that require pre-construction notification, the PCN must include any other NWP(s), regional general permit(s), or individual permit(s) used or intended to be used to authorize any part of the proposed project or any related activity, including other separate and distant crossings that require Department of the Army authorization but do not require pre-construction notification (see paragraph (b) of general condition 32). The district engineer will evaluate the PCN in accordance with Section D, "District Engineer's Decision." The district engineer may require mitigation to ensure that the authorized activity results in no more than minimal individual and cumulative adverse environmental effects (see general condition 23).

PART II
SPECIFICATIONS AND STANDARD DRAWINGS

SPECIFICATIONS REFERENCE

Any reference in the plans or proposal to previous editions of the *Standard Specifications for Road and Bridge Construction* and *Standard Drawings* are superseded by *Standard Specifications for Road and Bridge Construction, Edition of 2012* and *Standard Drawings, Edition of 2016*.

SUPPLEMENTAL SPECIFICATIONS

The contractor shall use the Supplemental Specifications that are effective at the time of letting.
The Supplemental Specifications can be found at the following link:

<http://transportation.ky.gov/Construction/Pages/Kentucky-Standard-Specifications.aspx>

PART III

EMPLOYMENT, WAGE AND RECORD REQUIREMENTS

**TRANSPORTATION CABINET
DEPARTMENT OF HIGHWAYS**

**LABOR AND WAGE REQUIREMENTS
APPLICABLE TO OTHER THAN FEDERAL-AID SYSTEM PROJECTS**

- I. Application
- II. Nondiscrimination of Employees (KRS 344)

I. APPLICATION

1. These contract provisions shall apply to all work performed on the contract by the contractor with his own organization and with the assistance of workmen under his immediate superintendence and to all work performed on the contract by piecework, station work or by subcontract. The contractor's organization shall be construed to include only workmen employed and paid directly by the contractor and equipment owned or rented by him, with or without operators.

2. The contractor shall insert in each of his subcontracts all of the stipulations contained in these Required Provisions and such other stipulations as may be required.

3. A breach of any of the stipulations contained in these Required Provisions may be grounds for termination of the contract.

3. If the contractor is in control of apprenticeship or other training or retraining, including on-the-job training programs, he shall not discriminate against an individual because of his race, color, religion, national origin, sex, disability or age forty (40) and over, in admission to, or employment in any program established to provide apprenticeship or other training.

4. The contractor will send to each labor union or representative of workers with which he has a collective bargaining agreement or other contract or understanding, a notice to be provided advising the said labor union or workers' representative of the contractor's commitments under this section, and shall post copies of the notice in conspicuous places available to employees and applicants for employment. The contractor will take such action with respect to any subcontract or purchase order as the administrating agency may direct as a means of enforcing such provisions, including sanctions for non-compliance.

Revised: January 25, 2017

II. NONDISCRIMINATION OF EMPLOYEES

**AN ACT OF THE KENTUCKY
GENERAL ASSEMBLY TO PREVENT
DISCRIMINATION IN EMPLOYMENT
KRS CHAPTER 344
EFFECTIVE JUNE 16, 1972**

The contract on this project, in accordance with KRS Chapter 344, provides that during the performance of this contract, the contractor agrees as follows:

1. The contractor shall not fail or refuse to hire, or shall not discharge any individual, or otherwise discriminate against an individual with respect to his compensation, terms, conditions, or privileges of employment, because of such individual's race, color, religion, national origin, sex, disability or age (forty and above); or limit, segregate, or classify his employees in any way which would deprive or tend to deprive an individual of employment opportunities or otherwise adversely affect his status as an employee, because of such individual's race, color, religion, national origin, sex, disability or age forty (40) and over. The contractor agrees to post in conspicuous places, available to employees and applicants for employment, notices to be provided setting forth the provisions of this nondiscrimination clause.

2. The contractor shall not print or publish or cause to be printed or published a notice or advertisement relating to employment by such an employer or membership in or any classification or referral for employment by the employment agency, indicating any preference, limitation, specification, or discrimination, based on race, color, religion, national origin, sex, or age forty (40) and over, or because the person is a qualified individual with a disability, except that such a notice or advertisement may indicate a preference, limitation, or specification based on religion, national origin, sex, or age forty (40) and over, or because the person is a qualified individual with a disability, when religion, national origin, sex, or age forty (40) and over, or because the person is a qualified individual with a disability, is a bona fide occupational qualification for employment.

EXECUTIVE BRANCH CODE OF ETHICS

In the 1992 regular legislative session, the General Assembly passed and Governor Brereton Jones signed Senate Bill 63 (codified as KRS 11A), the Executive Branch Code of Ethics, which states, in part:

KRS 11A.040 (7) provides:

No present or former public servant shall, within six (6) months following termination of his office or employment, accept employment, compensation, or other economic benefit from any person or business that contracts or does business with, or is regulated by, the state in matters in which he was directly involved during the last thirty-six (36) months of his tenure. This provision shall not prohibit an individual from returning to the same business, firm, occupation, or profession in which he was involved prior to taking office or beginning his term of employment, or for which he received, prior to his state employment, a professional degree or license, provided that, for a period of six (6) months, he personally refrains from working on any matter in which he was directly involved during the last thirty-six (36) months of his tenure in state government. This subsection shall not prohibit the performance of ministerial functions, including but not limited to filing tax returns, filing applications for permits or licenses, or filing incorporation papers, nor shall it prohibit the former officer or public servant from receiving public funds disbursed through entitlement programs.

KRS 11A.040 (9) states:

A former public servant shall not represent a person or business before a state agency in a matter in which the former public servant was directly involved during the last thirty-six (36) months of his tenure, for a period of one (1) year after the latter of:

- a) The date of leaving office or termination of employment; or
- b) The date the term of office expires to which the public servant was elected.

This law is intended to promote public confidence in the integrity of state government and to declare as public policy the idea that state employees should view their work as a public trust and not as a way to obtain private benefits.

If you have worked for the executive branch of state government within the past six months, you may be subject to the law's prohibitions. The law's applicability may be different if you hold elected office or are contemplating representation of another before a state agency.

Also, if you are affiliated with a firm which does business with the state and which employs former state executive-branch employees, you should be aware that the law may apply to them.

In case of doubt, the law permits you to request an advisory opinion from the Executive Branch Ethics Commission, 3 Fountain Place, Frankfort, Kentucky 40601; telephone (502) 564-7954.

Revised: January 27, 2017

Kentucky Equal Employment Opportunity Act of 1978

The requirements of the Kentucky Equal Employment Opportunity Act of 1978 (KRS 45.560-45.640) shall apply to this Contract. The apparent low Bidder will be required to submit EEO forms to the Division of Construction Procurement, which will then forward to the Finance and Administration Cabinet for review and approval. No award will become effective until all forms are submitted and EEO/CC has certified compliance. The required EEO forms are as follows:

- EEO-1: Employer Information Report
- Affidavit of Intent to Comply
- Employee Data Sheet
- Subcontractor Report

These forms are available on the Finance and Administration's web page under ***Vendor Information, Standard Attachments and General Terms*** at the following address:
<https://www.eProcurement.ky.gov>.

Bidders currently certified as being in compliance by the Finance and Administration Cabinet may submit a copy of their approval letter in lieu of the referenced EEO forms.

For questions or assistance please contact the Finance and Administration Cabinet by email at **finance.contractcompliance@ky.gov** or by phone at 502-564-2874.

EMPLOYEE RIGHTS UNDER THE FAIR LABOR STANDARDS ACT

THE UNITED STATES DEPARTMENT OF LABOR WAGE AND HOUR DIVISION

FEDERAL MINIMUM WAGE

\$7.25

 PER HOUR

BEGINNING JULY 24, 2009

OVERTIME PAY At least 1½ times your regular rate of pay for all hours worked over 40 in a workweek.

CHILD LABOR An employee must be at least **16** years old to work in most non-farm jobs and at least **18** to work in non-farm jobs declared hazardous by the Secretary of Labor.

Youths **14** and **15** years old may work outside school hours in various non-manufacturing, non-mining, non-hazardous jobs under the following conditions:

No more than

- **3** hours on a school day or **18** hours in a school week;
- **8** hours on a non-school day or **40** hours in a non-school week.

Also, work may not begin before **7 a.m.** or end after **7 p.m.**, except from June 1 through Labor Day, when evening hours are extended to **9 p.m.** Different rules apply in agricultural employment.

TIP CREDIT Employers of “tipped employees” must pay a cash wage of at least \$2.13 per hour if they claim a tip credit against their minimum wage obligation. If an employee’s tips combined with the employer’s cash wage of at least \$2.13 per hour do not equal the minimum hourly wage, the employer must make up the difference. Certain other conditions must also be met.

ENFORCEMENT The Department of Labor may recover back wages either administratively or through court action, for the employees that have been underpaid in violation of the law. Violations may result in civil or criminal action.

Employers may be assessed civil money penalties of up to \$1,100 for each willful or repeated violation of the minimum wage or overtime pay provisions of the law and up to \$11,000 for each employee who is the subject of a violation of the Act’s child labor provisions. In addition, a civil money penalty of up to \$50,000 may be assessed for each child labor violation that causes the death or serious injury of any minor employee, and such assessments may be doubled, up to \$100,000, when the violations are determined to be willful or repeated. The law also prohibits discriminating against or discharging workers who file a complaint or participate in any proceeding under the Act.

ADDITIONAL INFORMATION

- Certain occupations and establishments are exempt from the minimum wage and/or overtime pay provisions.
- Special provisions apply to workers in American Samoa and the Commonwealth of the Northern Mariana Islands.
- Some state laws provide greater employee protections; employers must comply with both.
- The law requires employers to display this poster where employees can readily see it.
- Employees under 20 years of age may be paid \$4.25 per hour during their first 90 consecutive calendar days of employment with an employer.
- Certain full-time students, student learners, apprentices, and workers with disabilities may be paid less than the minimum wage under special certificates issued by the Department of Labor.

For additional information:



1-866-4-USWAGE

(1-866-487-9243)

TTY: 1-877-889-5627



WWW.WAGEHOUR.DOL.GOV

PART IV
INSURANCE

INSURANCE

The Contractor shall procure and maintain the following insurance in addition to the insurance required by law:

- 1) Commercial General Liability-Occurrence form – not less than \$2,000,000 General aggregate, \$2,000,000 Products & Completed Aggregate, \$1,000,000 Personal & Advertising, \$1,000,000 each occurrence.
- 2) Automobile Liability- \$1,000,000 per accident
- 3) Employers Liability:
 - a) \$100,000 Each Accident Bodily Injury
 - b) \$500,000 Policy limit Bodily Injury by Disease
 - c) \$100,000 Each Employee Bodily Injury by Disease
- 4) The insurance required above must be evidenced by a Certificate of Insurance and this Certificate of Insurance must contain one of the following statements:
 - a) "policy contains no deductible clauses."
 - b) "policy contains _____ (amount) deductible property damage clause but company will pay claim and collect the deductible from the insured."
- 5) KENTUCKY WORKMEN'S COMPENSATION INSURANCE. The contractor shall furnish evidence of coverage of all his employees or give evidence of self-insurance by submitting a copy of a certificate issued by the Workmen's Compensation Board.

The cost of insurance is incidental to all contract items. All subcontractors must meet the same minimum insurance requirements.

PART V
BID ITEMS

PROPOSAL BID ITEMS

185013

Page 1 of 1

Report Date 11/13/18

Section: 0001 - PAVING

LINE	BID CODE	ALT	DESCRIPTION	QUANTITY	UNIT	UNIT PRIC	FP	AMOUNT
0010	00003		CRUSHED STONE BASE	17.00	TON		\$	
0020	00214		CL3 ASPH BASE 1.00D PG64-22	36.00	TON		\$	
0030	00339		CL3 ASPH SURF 0.38D PG64-22	8.00	TON		\$	
0040	02585		EDGE KEY	44.00	LF		\$	

Section: 0002 - ROADWAY

LINE	BID CODE	ALT	DESCRIPTION	QUANTITY	UNIT	UNIT PRIC	FP	AMOUNT
0050	02351		GUARDRAIL-STEEL W BEAM-S FACE	50.00	LF		\$	
0060	02355		GUARDRAIL-STEEL W BEAM-S FACE A	100.00	LF		\$	
0070	02381		REMOVE GUARDRAIL	150.00	LF		\$	
0080	02650		MAINTAIN & CONTROL TRAFFIC	1.00	LS		\$	
0090	06541		PAVE STRIPING-THERMO-4 IN Y	150.00	LF		\$	

Section: 0003 - BRIDGE

LINE	BID CODE	ALT	DESCRIPTION	QUANTITY	UNIT	UNIT PRIC	FP	AMOUNT
0100	03299		ARMORED EDGE FOR CONCRETE	62.00	LF		\$	
0110	08003		FOUNDATION PREPARATION	1.00	LS		\$	
0120	08100		CONCRETE-CLASS A	2.00	CUYD		\$	
0130	08104		CONCRETE-CLASS AA	38.00	CUYD		\$	
0140	08151		STEEL REINFORCEMENT-EPOXY COATED	11,580.00	LB		\$	
0150	08160		STRUCTURAL STEEL (APPROXIMATELY 25,697 LB)	1.00	LS		\$	
0160	08170		SHEAR CONNECTORS (APPROXIMATELY 768)	1.00	LS		\$	
0170	08301		REMOVE SUPERSTRUCTURE	1.00	LS		\$	
0180	08801		GUARDRAIL-STEEL W BEAM-S FACE BR	87.50	LF		\$	
0190	22146EN		CONCRETE PATCHING REPAIR	50.00	SQFT		\$	
0200	23378EC		CONCRETE SEALING	1,111.00	SQFT		\$	
0210	23380EC		BEARING PADS	8.00	EACH		\$	
0220	23744EC		EPOXY INJECTION CRACK REPAIR	16.00	LF		\$	

Section: 0004 - DEMOBILIZATION &/OR MOBILIZATION

LINE	BID CODE	ALT	DESCRIPTION	QUANTITY	UNIT	UNIT PRIC	FP	AMOUNT
0230	02569		DEMOBILIZATION	1.00	LS		\$	